



TEST REPORT

Reference No...... : WTF22X04082738W003
Manufacturer : Mid Ocean Brands B.V.
Address : 7/F., Kings Tower, 111 King Lam Street, Cheung Sha Wan, Kowloon, Hong Kong
Factory..... : 114746
Product Name : Wireless bamboo speaker
Model No...... : MO6669
Standards : EN 55032:2015+A11:2020; EN 55035:2017+A11:2020
EN IEC 61000-3-2:2019; EN 61000-3-3:2013+A1:2019
ETSI EN 301 489-1 V2.2.3 (2019-11)
ETSI EN 301 489-17 V3.2.4 (2020-09)
Date of Receipt sample : 2022-04-28
Date of Test..... : 2022-04-28 to 2022-05-27
Date of Issue : 2022-05-27
Test Report Form No. : WTX_ETSI EN 301 489_1_2019W
Test Result..... : **Pass**

Remarks:

The results shown in this test report refer only to the sample(s) tested, this test report cannot be reproduced, except in full, without prior written permission of the company. The report would be invalid without specific stamp of test institute and the signatures of approver.

Prepared By:

Waltek Testing Group (Shenzhen) Co., Ltd.

Address: 1/F., Room 101, Building 1, Hongwei Industrial Park, Liuxian 2nd Road,
Block 70 Bao'an District, Shenzhen, Guangdong, China
Tel.: +86-755-33663308 Fax.: +86-755-33663309 Email: sem@waltek.com.cn

Tested by:

Jack Huang

Jack Huang

Approved by:

Silin Chen

Silin Chen



TABLE OF CONTENTS

1. GENERAL INFORMATION.....	5
1.2 TEST STANDARDS.....	6
1.3 TEST METHODOLOGY.....	6
1.4 TEST FACILITY.....	6
1.5 EUT SETUP AND OPERATION MODE.....	7
1.6 PERFORMANCE CRITERIA FOR EMS.....	8
1.7 MEASUREMENT UNCERTAINTY.....	10
1.8 TEST EQUIPMENT LIST AND DETAILS.....	11
2. SUMMARY OF TEST RESULTS.....	13
3. CONDUCTED EMISSIONS.....	14
3.1 TEST PROCEDURE.....	14
3.2 BASIC TEST SETUP BLOCK DIAGRAM.....	14
3.3 ENVIRONMENTAL CONDITIONS.....	14
3.4 CONDUCTED EMISSIONS TEST DATA.....	14
4. RADIATED EMISSIONS.....	19
4.1 TEST PROCEDURE.....	19
4.2 CORRECTED AMPLITUDE & MARGIN CALCULATION.....	19
4.3 ENVIRONMENTAL CONDITIONS.....	20
4.4 SUMMARY OF TEST RESULTS/PLOTS.....	20
5. HARMONIC CURRENT EMISSIONS.....	26
5.1 TEST PROCEDURE.....	26
5.2 TEST SETUP BLOCK DIAGRAM.....	26
5.3 TEST STANDARDS.....	26
5.4 ENVIRONMENTAL CONDITIONS.....	26
5.5 HARMONIC CURRENT EMISSIONS TEST DATA.....	26
6. VOLTAGE FLUCTUATION AND FLICKER.....	32
6.1 TEST PROCEDURE.....	32
6.2 TEST SETUP BLOCK DIAGRAM.....	32
6.3 TEST STANDARDS.....	32
6.4 ENVIRONMENTAL CONDITIONS.....	32
6.5 VOLTAGE FLUCTUATION AND FLICKER TEST DATA.....	32
7. ELECTROSTATIC DISCHARGE (ESD).....	34
7.1 TEST PROCEDURE.....	34
7.2 TEST SETUP BLOCK DIAGRAM.....	34
7.3 TEST PERFORMANCE.....	34
7.4 ENVIRONMENTAL CONDITIONS.....	34
7.5 ELECTROSTATIC DISCHARGE IMMUNITY TEST DATA.....	34
8. RADIO FREQUENCY ELECTROMAGNETIC FIELD (R/S).....	36
8.1 TEST PROCEDURE.....	36
8.2 TEST SETUP BLOCK DIAGRAM.....	36
8.3 TEST PERFORMANCE.....	36
8.4 ENVIRONMENTAL CONDITIONS.....	36
8.5 CONTINUOUS RADIATED DISTURBANCES TEST DATA.....	36
9. FAST TRANSIENTS, COMMON MODE (EFT).....	38
9.1 TEST PROCEDURE.....	38
9.2 TEST SETUP BLOCK DIAGRAM.....	38
9.3 TEST PERFORMANCE.....	38
9.4 ENVIRONMENTAL CONDITIONS.....	38
9.5 ELECTRICAL FAST TRANSIENTS TEST DATA.....	38
10. SURGES.....	40



Reference No.: WTF22X04082738W003

10.1 TEST PROCEDURE.....	40
10.2 TEST SETUP BLOCK DIAGRAM.....	40
10.3 TEST PERFORMANCE	40
10.4 ENVIRONMENTAL CONDITIONS.....	40
10.5 SURGE TEST DATA.....	40
11. RADIO FREQUENCY, COMMON MODE (C/S)	42
11.1 TEST PROCEDURE.....	42
11.2 TEST SETUP BLOCK DIAGRAM.....	42
11.3 TEST PERFORMANCE	42
11.4 ENVIRONMENTAL CONDITIONS.....	42
11.5 CONTINUOUS CONDUCTED DISTURBANCES TEST DATA	42
12. VOLTAGE DIPS AND INTERRUPTIONS.....	44
12.1 TEST PROCEDURE.....	44
12.2 TEST SETUP BLOCK DIAGRAM.....	44
12.3 TEST PERFORMANCE	44
12.4 ENVIRONMENTAL CONDITIONS.....	44
12.5 VOLTAGE DIPS AND INTERRUPTIONS TEST DATA	44
EXHIBIT 1 - EUT PHOTOGRAPHS.....	45
EXHIBIT 2 - TEST SETUP PHOTOGRAPHS.....	46

WALTEK



Report version

Version No.	Date of issue	Description
Rev.00	2022-05-27	Original
/	/	/

WALTEK



1. GENERAL INFORMATION

1.1 Product Description for Equipment Under Test (EUT)

General Description of EUT	
Product Name:	Wireless bamboo speaker
Trade Name:	/
Model No.:	MO6669
Adding Model(s):	/
Rated Voltage:	Battery DC 3.7V
Battery Capacity:	300mAh
Power Adapter:	/
Software Version:	1.0
Hardware Version:	1.0
<i>Note: The test data is gathered from a production sample, provided by the manufacturer.</i>	

Technical Characteristics of EUT	
Bluetooth	
Bluetooth Version:	Bluetooth V5.0(Only EDR)
Frequency Range:	2402-2480MHz
Max.RF Output Power:	-1.63dBm (EIRP)
Type of Modulation:	GFSK, $\pi/4$ DQPSK
Data Rate:	1Mbps, 2Mbps
Quantity of Channels	79
Channel Separation:	1MHz
Type of Antenna:	PCB Antenna
Antenna Gain:	-0.58dBi
<i>Note: The Antenna Gain is provided by the customer and can affect the validity of results.</i>	



1.2 Test Standards

The tests were performed according to following standards:

EN 55032:2015+A11:2020: Electromagnetic compatibility of multimedia equipment - Emission requirements

EN 55035:2017+A11:2020: Electromagnetic compatibility of multimedia equipment - Immunity requirements.

EN IEC 61000-3-2:2019: Electromagnetic compatibility (EMC) -- Part 3-2: Limits - Limits for harmonic current emissions (equipment input current up to and including 16 A per phase).

EN 61000-3-3:2013+A1:2019: Electromagnetic compatibility (EMC) -- Part 3-3: Limits - Limitation of voltage changes, voltage fluctuations and flicker in public low-voltage supply systems, for equipment with rated current ≤ 16 A per phase and not subject to conditional connection.

ETSI EN 301 489-1 V2.2.3 (2019-11): Electromagnetic Compatibility (EMC) standard for radio equipment and services; Part 1: Common technical requirements; Harmonised Standard for Electromagnetic Compatibility.

ETSI EN 301 489-17 V3.2.4 (2020-09): ElectroMagnetic Compatibility (EMC) standard for radio equipment and services; Part 17: Specific conditions for Broadband Data Transmission Systems; Harmonised Standard for ElectroMagnetic Compatibility.

Maintenance of compliance is the responsibility of the manufacturer. Any modification of the product maybe which result in lowering the emission/immunity should be checked to ensure compliance has been maintained.

1.3 Test Methodology

All measurements contained in this report were conducted with the standard ETSI EN 301489-1, Electromagnetic compatibility and Radio spectrum Matters (ERM); Electromagnetic Compatibility (EMC) standard for radio equipment and services; Part 1: Common technical requirements.

1.4 Test Facility

FCC – Registration No.: 125990

Waltek Testing Group (Shenzhen) Co., Ltd. Laboratory has been recognized to perform compliance testing on equipment subject to the Commissions Declaration Of Conformity (DOC). The Designation Number is CN5010, and Test Firm Registration Number is 125990.

Industry Canada (IC) Registration No.: 11464A

The 3m Semi-anechoic chamber of Waltek Testing Group (Shenzhen) Co., Ltd. has been registered by Certification and Engineering Bureau of Industry Canada for radio equipment testing with Registration No.: 11464A.



1.5 EUT Setup and Operation Mode

The equipment under test (EUT) was configured to measure its highest possible emission/immunity level. The test modes were adapted according to the operation manual for use, more detailed description as follows:

Test Mode List		
Test Mode	Description	Remark
TM1	Charging	Connect to the Adapter; AC230V 50Hz for Adapter
TM2	Bluetooth Playing	Connect to the Adapter; AC230V 50Hz for adapter; Connect the phone
TM3	Bluetooth	TR, CR, TT, CT for EMS testing

EUT Cable List and Details			
Cable Description	Length (m)	Shielded/Unshielded	With / Without Ferrite
USB Cable	0.50	Unshielded	Without Ferrite

Special Cable List and Details			
Cable Description	Length (m)	Shielded/Unshielded	With / Without Ferrite
/	/	/	/

Auxiliary Equipment List and Details			
Description	Manufacturer	Model	Serial Number
Mobile phone	HUAWEI	VOG-AL00	/
Notebook	Lenovo	E445	EB12648265
Adapter	PD	PD-051	/



1.6 Performance Criteria for EMS

➤ EN 301 489-17, The performance criteria are:

- performance criteria A for immunity tests with phenomena of a continuous nature;
- performance criteria B for immunity tests with phenomena of a transient nature;
- performance criteria C for immunity tests with power interruptions exceeding a certain time.

The equipment shall meet the minimum performance criteria as specified in the following clauses.

Table 1: Performance criteria

Criteria	During test	After test
A	Shall operate as intended. (see note 1). Shall be no loss of function. Shall be no unintentional transmissions.	Shall operate as intended. Shall be no degradation of performance (see note 3). Shall be no loss of function. Shall be no loss of stored data or user programmable functions.
B	May show loss of function (one or more). May show degradation of performance (see note 2). Shall be no unintentional transmissions.	Functions shall be self-recoverable. Shall operate as intended after recovering. Shall be no degradation of performance (see note 3). Shall be no loss of stored data or user programmable functions.
C	May be loss of function (one or more).	Functions shall be recoverable by the operator. Shall operate as intended after recovering. Shall be no degradation of performance (see note 3).

NOTE 1: Operate as intended during the test allows a level of degradation not below a minimum performance level specified by the manufacturer for the use of the apparatus as intended. In some cases the specified minimum performance level may be replaced by a permissible degradation of performance. If the minimum performance level or the permissible performance degradation is not specified by the manufacturer then either of these may be derived from the product description and documentation (including leaflets and advertising) and what the user may reasonably expect from the apparatus if used as intended.

NOTE 2: Degradation of performance during the test is understood as a degradation to a level not below a minimum performance level specified by the manufacturer for the use of the apparatus as intended. In some cases the specified minimum performance level may be replaced by a permissible degradation of performance. If the minimum performance level or the permissible performance degradation is not specified by the manufacturer then either of these may be derived from the product description and documentation (including leaflets and advertising) and what the user may reasonably expect from the apparatus if used as intended.

NOTE 3: No degradation of performance after the test is understood as no degradation below a minimum performance level specified by the manufacturer for the use of the apparatus as intended. In some cases the specified minimum performance level may be replaced by a permissible degradation of performance. After the test no change of actual operating data or user retrievable data is allowed. If the minimum performance level or the permissible performance degradation is not specified by the manufacturer then either of these may be derived from the product description and documentation (including leaflets and advertising) and what the user may reasonably expect from the apparatus if used as intended.



➤ **EN 55035, The performance criteria are:**

- A. The apparatus shall continue to operate as intended during and after the test. The manufacturer specifies some minimum performance level. The performance level may be specified by the manufacturer as a permissible loss of performance.
- B. The apparatus shall continue to operate as intended after the test. This indicates that the EUT does not need to function at normal performance levels during the test, but must recover. Again some minimal performance is defined by the manufacture. No change in operating state or loss or data is permitted.
- C. Temporary loss of function is allowed. Operation of the EUT may stop as long as it is either automatically reset or can be manually restored by operation of the controls.

WALTEK



1.7 Measurement Uncertainty

Measurement uncertainty	
Parameter	Uncertainty
Uncertainty for Radiated Emission in 3m chamber	@30-200MHz ± 4.52 dB @0.2-1GHz ± 5.56 dB @1-6GHz ± 3.84 dB @6-18GHz ± 3.92 dB
Uncertainty for Conducted Emission	@9-150kHz ± 3.74 dB @0.15-30MHz ± 3.34 dB
Uncertainty for Harmonic test	3.26%
Uncertainty for Flicker test	4.76%
Uncertainty for RS test	21%, k=2
Uncertainty for CS test	29%, k=2
Uncertainty for ESD test	The immunity measurement system uncertainty is within standard requirement and is based on a standard uncertainty multiplied by a coverage factor k=2, providing a level of confidence of approximately 95%.
Uncertainty for EFT test	
Uncertainty for Surges test	
Uncertainty for Voltage Dips, Voltage Variations and Short Interruptions Test	
Uncertainty for PFMF test	



1.8 Test Equipment List and Details

Description	Manufacturer	Model	Serial Number	Cal Date	Due Date
<input checked="" type="checkbox"/> Chamber A: Below 1GHz					
Spectrum Analyzer	Rohde & Schwarz	FSP30	836079/035	2022-03-22	2023-03-21
EMI Test Receiver	Rohde & Schwarz	ESVB	825471/005	2022-03-22	2023-03-21
Amplifier	Agilent	8447F	3113A06717	2022-01-07	2023-01-06
Loop Antenna	Schwarz beck	FMZB 1516	9773	2021-03-20	2023-03-19
Trilog Broadband Antenna	Schwarz beck	VULB9163	9163-333	2021-03-20	2023-03-19
<input checked="" type="checkbox"/> Chamber A: Above 1GHz					
Spectrum Analyzer	Rohde & Schwarz	FSP30	836079/035	2022-03-22	2023-03-21
Spectrum Analyzer	Rohde & Schwarz	FSP40	100612	2022-03-22	2023-03-21
EMI Test Receiver	Rohde & Schwarz	ESVB	825471/005	2022-03-22	2023-03-21
Amplifier	C&D	PAP-1G18	2002	2022-03-22	2023-03-21
Horn Antenna	ETS	3117	00086197	2021-03-19	2023-03-18
Horn Antenna	Schwarzbeck	BBHA 9170	BBHA9170582	2021-04-27	2023-04-26
Pre-amplifier	Schwarz beck	BBV 9721	9721-031	2022-03-25	2023-03-24
<input type="checkbox"/> Chamber B: Below 1GHz					
Trilog Broadband Antenna	Schwarz beck	VULB9163(B)	9163-635	2021-04-09	2023-04-08
Amplifier	Agilent	8447D	2944A10179	2022-03-22	2023-03-21
EMI Test Receiver	Rohde & Schwarz	ESPI	101391	2022-03-25	2023-03-24
<input type="checkbox"/> Chamber C: Below 1GHz					
EMI Test Receiver	Rohde & Schwarz	ESIB 26	100401	2022-01-07	2023-01-06
Trilog Broadband Antenna	Schwarz beck	VULB 9168	1194	2021-05-28	2023-05-27
Amplifier	HP	8447F	2944A03869	2022-03-22	2023-03-21
<input checked="" type="checkbox"/> Conducted Room 1#					
EMI Test Receiver	Rohde & Schwarz	ESPI	101611	2022-03-22	2023-03-21
Pulse Limiter	Rohde & Schwarz	ESH3-Z2	100911	2022-03-25	2023-03-24
AC LISN	Schwarz beck	NSLK8126	8126-224	2022-03-22	2023-03-21
8-WIRE LISN	Schwarz beck	8158	CAT3-8158-0059	2022-03-22	2023-03-21
8-WIRE LISN	Schwarz beck	8158	CAT5-8158-0117	2022-03-22	2023-03-21
<input type="checkbox"/> Conducted Room 2#					
EMI Test Receiver	Rohde & Schwarz	ESPI	10129	2022-03-22	2023-03-21
LISN	Rohde & Schwarz	ENV 216	100097	2022-03-22	2023-03-21
EMF					
VDH Test Head	AFJ	VDH 30	SC022Z	2022-03-25	2023-03-24
3 Loop Antenna					
Loop Antenna	ZHINAN	ZN30401	19037	2021-04-26	2023-04-25



Clamp					
Clamp	Luthi	MDS21	3809	2022-03-28	2023-03-27
PFMF					
PMF Generator	LIONCEL	PMF-801C-C	0171101	2022-03-22	2023-03-21
PMF Antenna	LIONCEL	PMF-801C-A	0180302	2022-03-22	2023-03-21
Instantaneous PMF Generator Module	LIONCEL	PMF-801C-T	0171001	2022-03-22	2023-03-21
H/F					
Digital Power Analyzer	California Instrument	CTS	72831	2022-03-22	2023-03-21
Power Source	California Instrument	5001IX-CTS-400	25965	2022-03-22	2023-03-21
ESD					
ESD Generator	LIONCEL	ESD-203B	0170901	2022-03-28	2023-03-27
EFT/SURGE/DIPS					
Transient 2000	EMC PARTNER	TRA2000	863	2022-03-22	2023-03-21
Couple Clamp	EMC PARTNER	CN-EFT1000	513	2022-03-22	2023-03-21
CS					
CONDUCTED IMMUNITY TEST SYSTEM	FRANKONIA	CIT-10/75	126B1247/2013	2022-01-07	2023-01-06
Attenuator	EMTEST	MA-5100/6BF2	1009	2022-03-22	2023-03-21
CDN	Luthi	L-801M2/M3	2665	2022-03-22	2023-03-21
CDN	LIONCEL	CDN-T8	0210401	2022-03-25	2023-03-24
EM Clamp	TESEQ	KEMZ801A	45028	2022-03-25	2023-03-24
RS					
Signal Generator	HP	8688B	3438A00604	2022-03-22	2023-03-21
Power Meter	KEITHLEY	3500	1162591	2022-03-22	2023-03-21
Power Meter	KEITHLEY	3500	1121428	2022-03-22	2023-03-21
RF Power Amplifier	MicoTop	MPA-80-1000-250	MPA1906239	2022-03-22	2023-03-21
RF Power Amplifier	MicoTop	MPA-80-6000-100	MPA1906238	2022-03-22	2023-03-21
Antenna	SCHWARZBECK	STLP 9129	9129 114	N/A	N/A
Power Meter	Agilent	E4419B	GB42420578	2022-03-22	2023-03-21

Software List			
Description	Manufacturer	Model	Version
EMI Test Software (Radiated Emission)*	Farad	EZ-EMC	RA-03A1
EMI Test Software (Conducted Emission)*	Farad	EZ-EMC	RA-03A1

*Remark: indicates software version used in the compliance certification testing.



2. SUMMARY OF TEST RESULTS

Standards	Reference	Description of Test Item	Result
ETSI EN 301 489-1	8.2	Radiated Emissions	Pass
	8.3	Conducted Emissions for DC Power Port	N/A
	8.4	Conducted Emissions for AC Power Port	Pass
	8.5	Harmonic Current Emissions	Pass
	8.6	Voltage Fluctuations and Flicker	Pass
	8.7	Telecommunication Ports	N/A
	9.2	Radio Frequency Electromagnetic Field	Pass
	9.3	Electrostatic Discharge	Pass
	9.4	Fast Transients, Common Mode	Pass
	9.5	Radio Frequency, Common Mode	Pass
	9.6	Transient and Surges in the Vehicular Environment	N/A
	9.7	Voltage Dips and Interruptions	Pass
	9.8	Surges	Pass

Pass: The EUT complies with the essential requirements in the standard.

Fail: The EUT does not comply with the essential requirements in the standard.

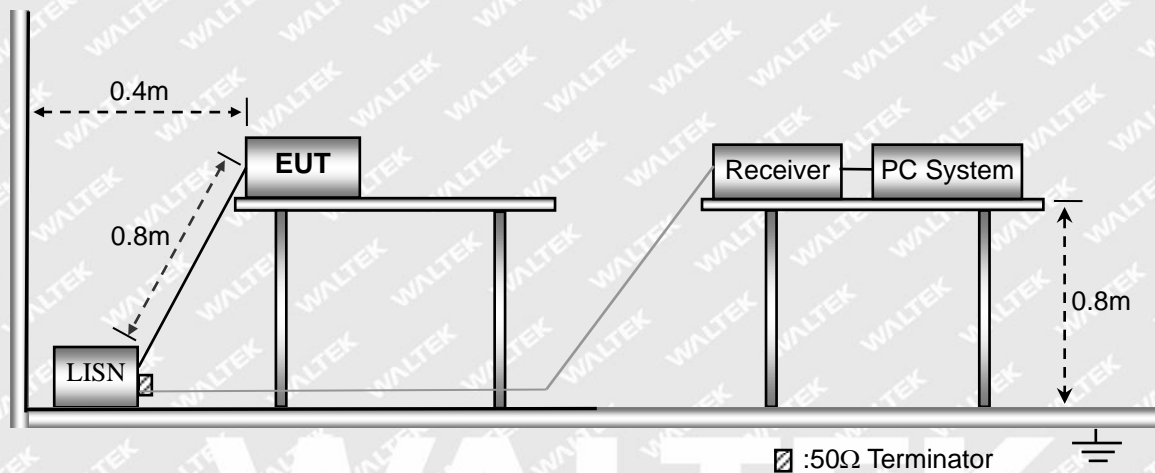
N/A: Not applicable.

3. Conducted Emissions

3.1 Test Procedure

Test is conducting under the description of EN55032 Information technology equipment - Radio disturbance characteristics - Limits and methods of measurement.

3.2 Basic Test Setup Block Diagram



3.3 Environmental Conditions

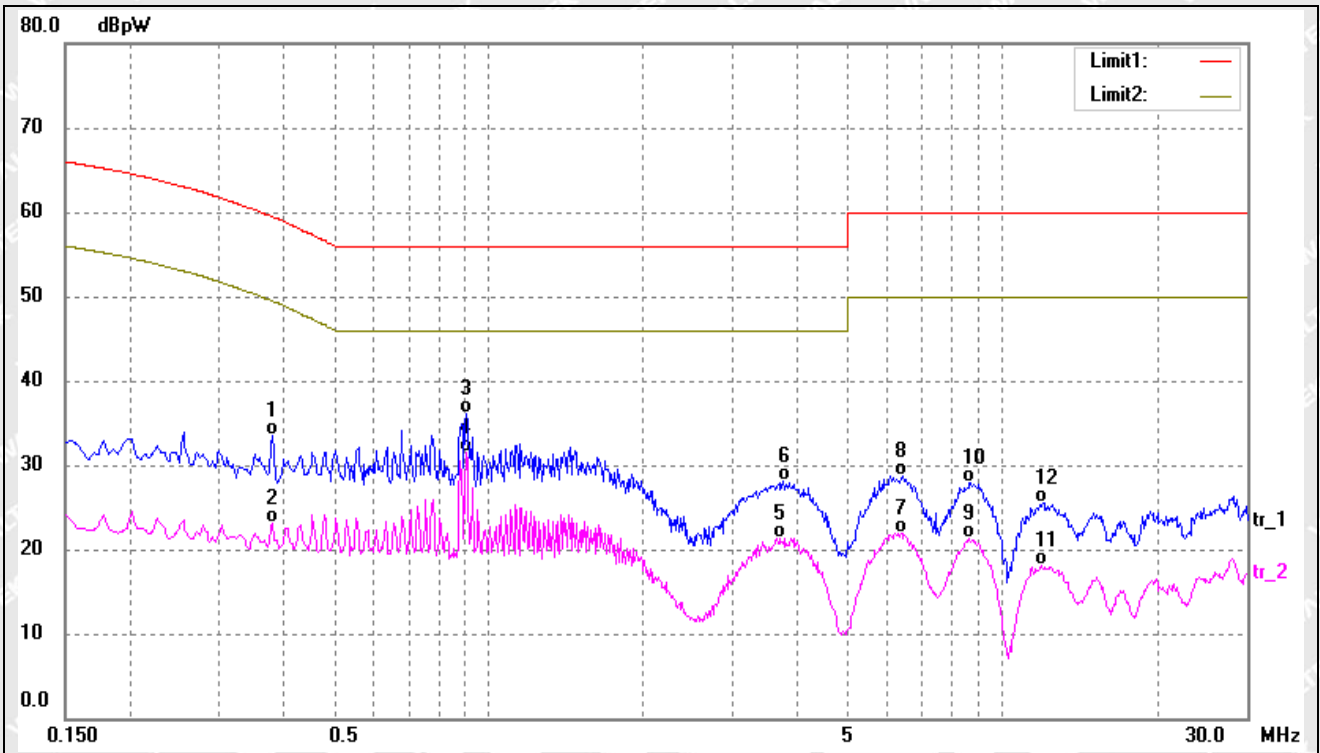
Temperature:	23.5 °C
Relative Humidity:	54 %
ATM Pressure:	1015 mbar

3.4 Conducted Emissions Test Data

Note: Only show the worst case in the test report



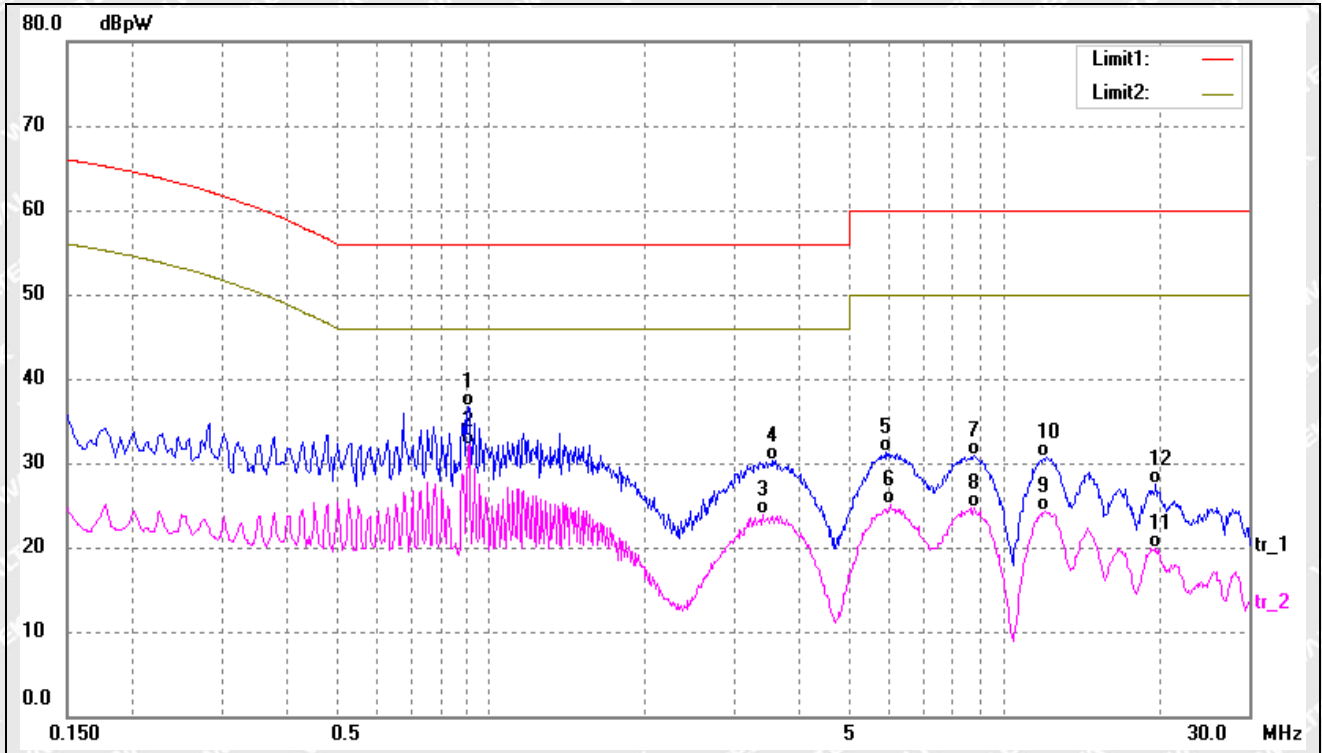
Test mode:	TM1	Polarity:	Neutral
------------	-----	-----------	---------



No.	Frequency (MHz)	Reading (dBuV)	Correct (dB)	Result (dBuV)	Limit (dBuV)	Margin (dB)	Detector
1	0.3780	23.16	10.30	33.46	59.48	-26.02	QP
2	0.3780	12.85	10.30	23.15	49.48	-26.33	AVG
3	0.9060	25.59	10.50	36.09	56.00	-19.91	QP
4*	0.9060	21.04	10.50	31.54	46.00	-14.46	AVG
5	3.6860	11.28	10.06	21.34	46.00	-24.66	AVG
6	3.7420	17.98	10.05	28.03	56.00	-27.97	QP
7	6.3780	11.98	9.96	21.94	50.00	-28.06	AVG
8	6.4500	18.73	9.96	28.69	60.00	-31.31	QP
9	8.6340	11.48	9.91	21.39	50.00	-28.61	AVG
10	8.7060	17.93	9.91	27.84	60.00	-32.16	QP
11	11.9580	8.11	9.98	18.09	50.00	-31.91	AVG
12	12.0020	15.61	9.98	25.59	60.00	-34.41	QP



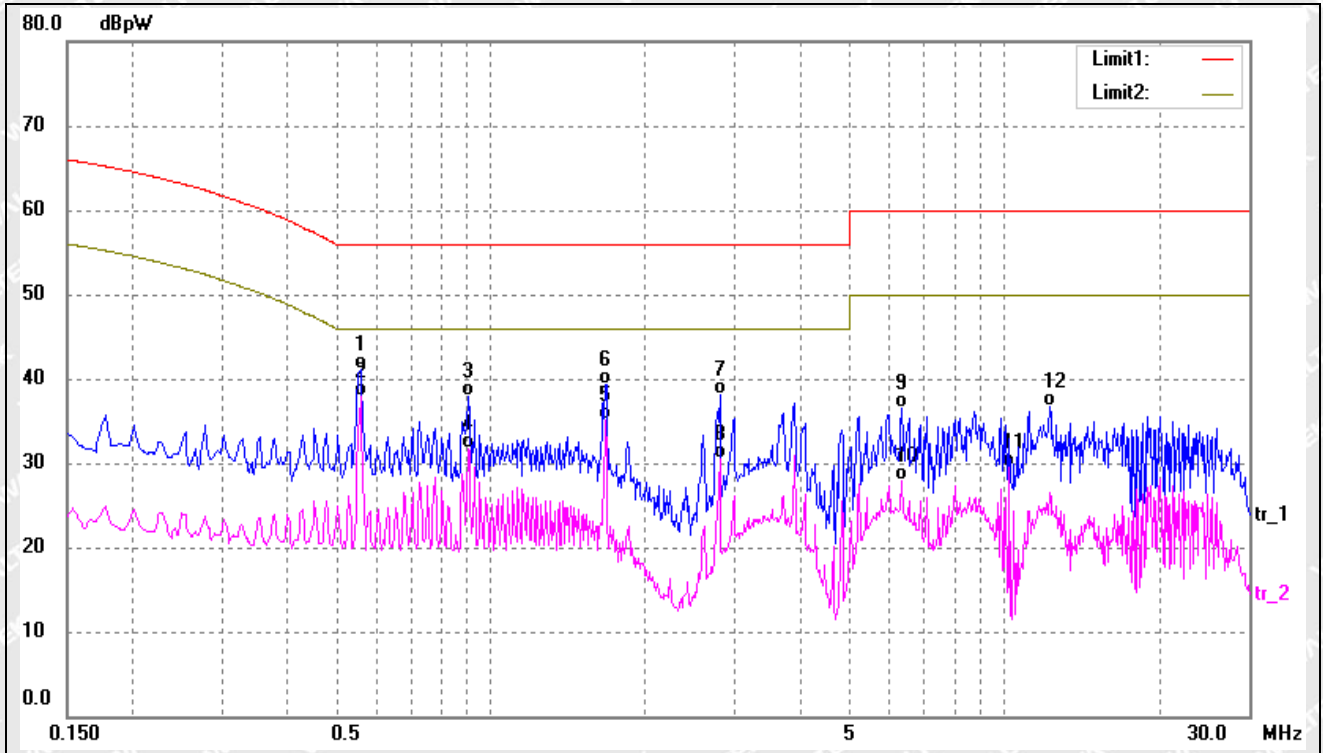
Test mode:	TM1	Polarity:	Line
------------	-----	-----------	------



No.	Frequency (MHz)	Reading (dBuV)	Correct (dB)	Result (dBuV)	Limit (dBuV)	Margin (dB)	Detector
1	0.9060	26.30	10.50	36.80	56.00	-19.20	QP
2*	0.9060	21.68	10.50	32.18	46.00	-13.82	AVG
3	3.3860	13.89	10.07	23.96	46.00	-22.04	AVG
4	3.5380	20.32	10.06	30.38	56.00	-25.62	QP
5	5.8780	21.31	9.97	31.28	60.00	-28.72	QP
6	6.0060	15.14	9.97	25.11	50.00	-24.89	AVG
7	8.7299	20.97	9.91	30.88	60.00	-29.12	QP
8	8.7299	14.82	9.91	24.73	50.00	-25.27	AVG
9	12.0460	14.26	9.98	24.24	50.00	-25.76	AVG
10	12.1420	20.73	9.99	30.72	60.00	-29.28	QP
11	19.7139	9.68	10.24	19.92	50.00	-30.08	AVG
12	19.7780	17.25	10.25	27.50	60.00	-32.50	QP



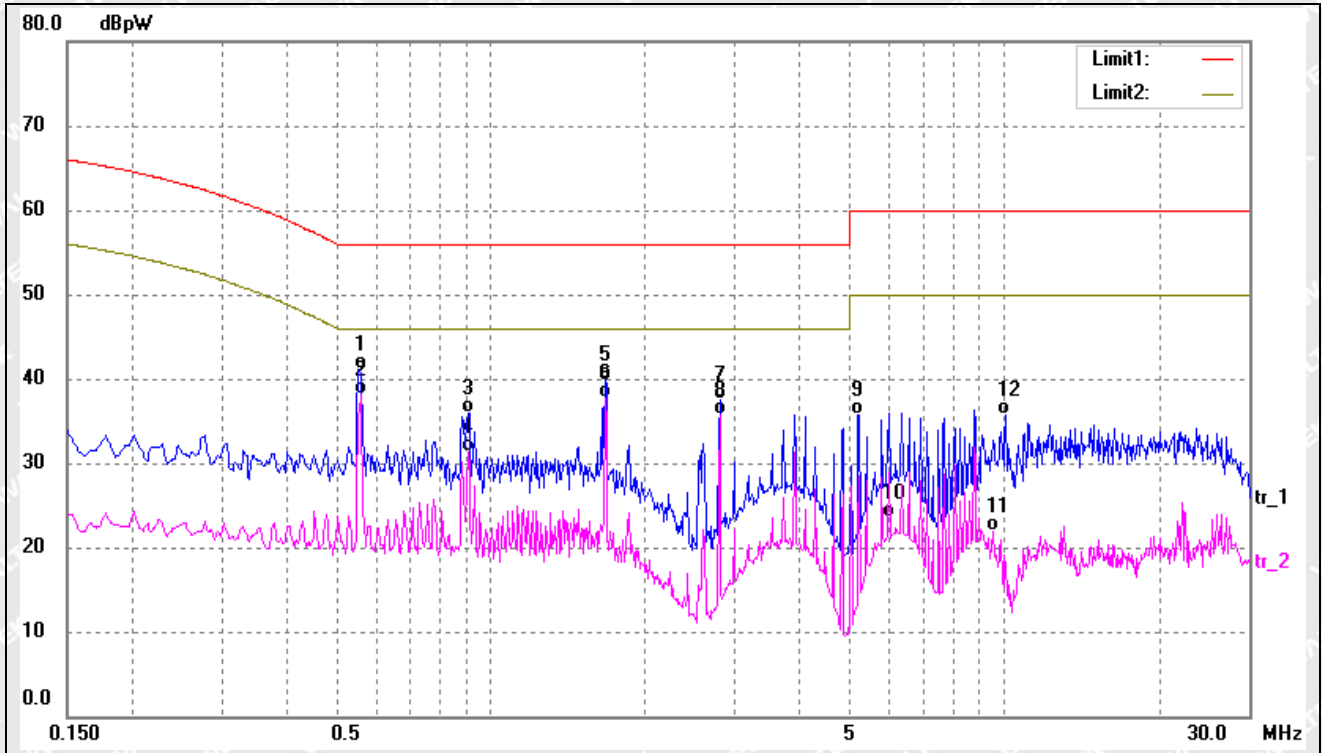
Test mode:	TM2	Polarity:	Neutral
------------	-----	-----------	---------



No.	Frequency (MHz)	Reading (dBUV)	Correct (dB)	Result (dBUV)	Limit (dBUV)	Margin (dB)	Detector
1	0.5580	30.88	10.29	41.17	56.00	-14.83	QP
2*	0.5580	27.70	10.29	37.99	46.00	-8.01	AVG
3	0.9060	27.49	10.50	37.99	56.00	-18.01	QP
4	0.9060	21.25	10.50	31.75	46.00	-14.25	AVG
5	1.6779	24.90	10.27	35.17	46.00	-10.83	AVG
6	1.6819	29.06	10.27	39.33	56.00	-16.67	QP
7	2.7980	27.98	10.10	38.08	56.00	-17.92	QP
8	2.7980	20.42	10.10	30.52	46.00	-15.48	AVG
9	6.3419	26.49	9.96	36.45	60.00	-23.55	QP
10	6.3419	17.89	9.96	27.85	50.00	-22.15	AVG
11	10.2660	19.58	9.89	29.47	50.00	-20.53	AVG
12	12.3179	26.67	10.00	36.67	60.00	-23.33	QP



Test mode:	TM2	Polarity:	Line
------------	-----	-----------	------



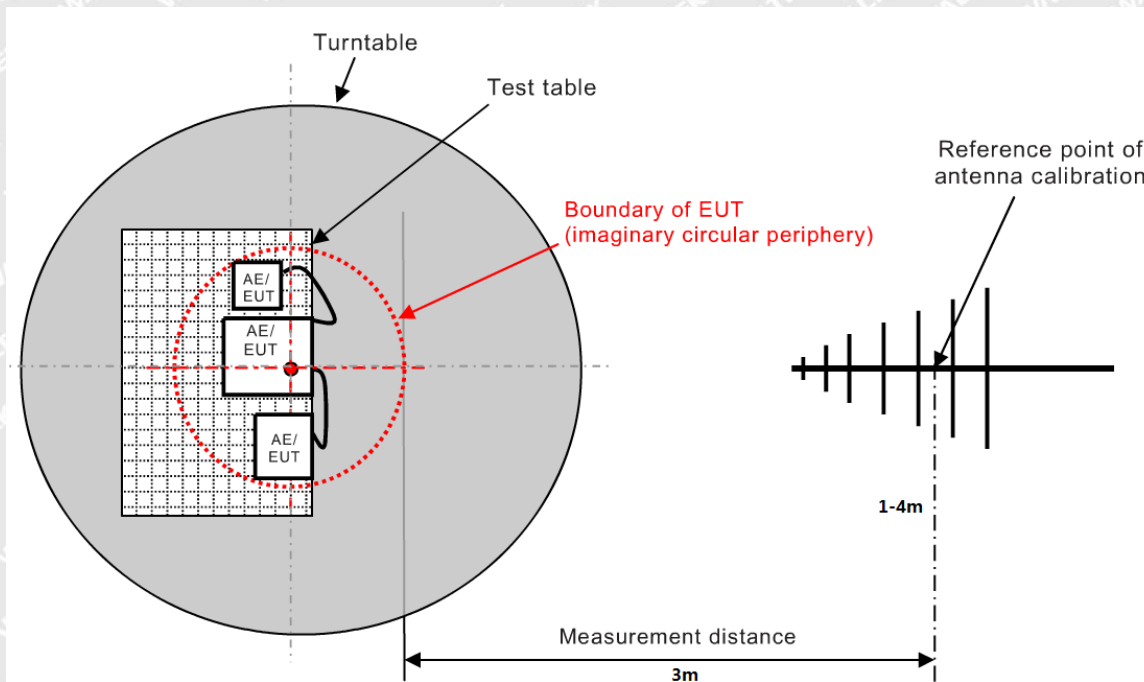
No.	Frequency (MHz)	Reading (dBuV)	Correct (dB)	Result (dBuV)	Limit (dBuV)	Margin (dB)	Detector
1	0.5540	30.80	10.29	41.09	56.00	-14.91	QP
2*	0.5580	27.86	10.29	38.15	46.00	-7.85	AVG
3	0.9060	25.45	10.50	35.95	56.00	-20.05	QP
4	0.9060	20.81	10.50	31.31	46.00	-14.69	AVG
5	1.6780	29.66	10.27	39.93	56.00	-16.07	QP
6	1.6780	27.49	10.27	37.76	46.00	-8.24	AVG
7	2.7980	27.37	10.10	37.47	56.00	-18.53	QP
8	2.7980	25.63	10.10	35.73	46.00	-10.27	AVG
9	5.2180	25.71	10.00	35.71	60.00	-24.29	QP
10	5.9699	13.46	9.97	23.43	50.00	-26.57	AVG
11	9.5100	12.06	9.88	21.94	50.00	-28.06	AVG
12	10.0820	25.82	9.87	35.69	60.00	-24.31	QP



4. Radiated Emissions

4.1 Test Procedure

Test is conducting under the description of EN55032 Information technology equipment - Radio disturbance characteristics - Limits and methods of measurement.



4.2 Corrected Amplitude & Margin Calculation

The Corrected Amplitude is calculated by adding the Antenna Factor and the Cable Factor, and subtracting the Amplifier Gain from the Amplitude reading. The basic equation is as follows:

$$\text{Corr. Ampl.} = \text{Indicated Reading} + \text{Antenna Factor} + \text{Cable Factor} - \text{Amplifier Gain}$$

The “**Margin**” column of the following data tables indicates the degree of compliance with the applicable limit. For example, a margin of $-6\text{dB}\mu\text{V}$ means the emission is $6\text{dB}\mu\text{V}$ below the maximum limit for Class B device. The equation for margin calculation is as follows:

$$\text{Margin} = \text{Corr. Ampl.} - \text{EN 301489 Class B Limit}$$



4.3 Environmental Conditions

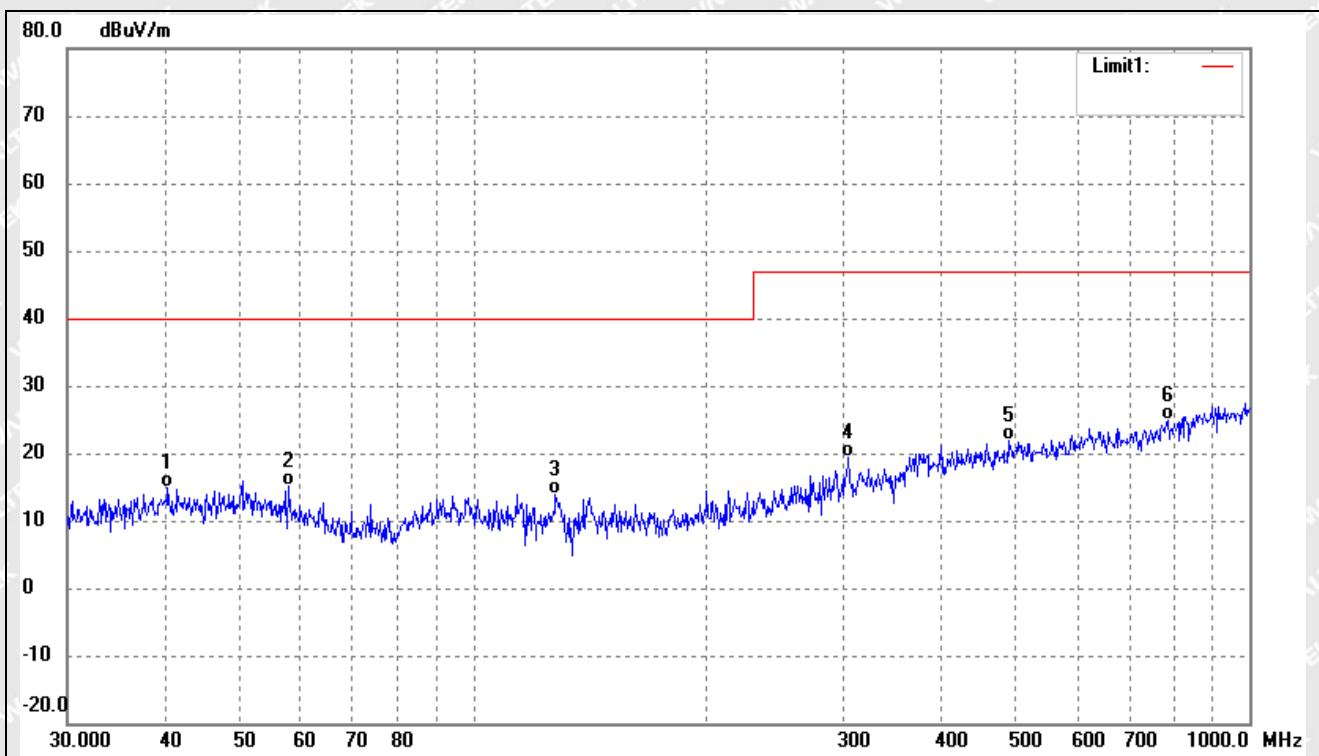
Temperature:	24° C
Relative Humidity:	55%
ATM Pressure:	1011 mbar

4.4 Summary of Test Results/Plots

Note: Only show the worst case in the test report

➤ 30MHz to 1GHz

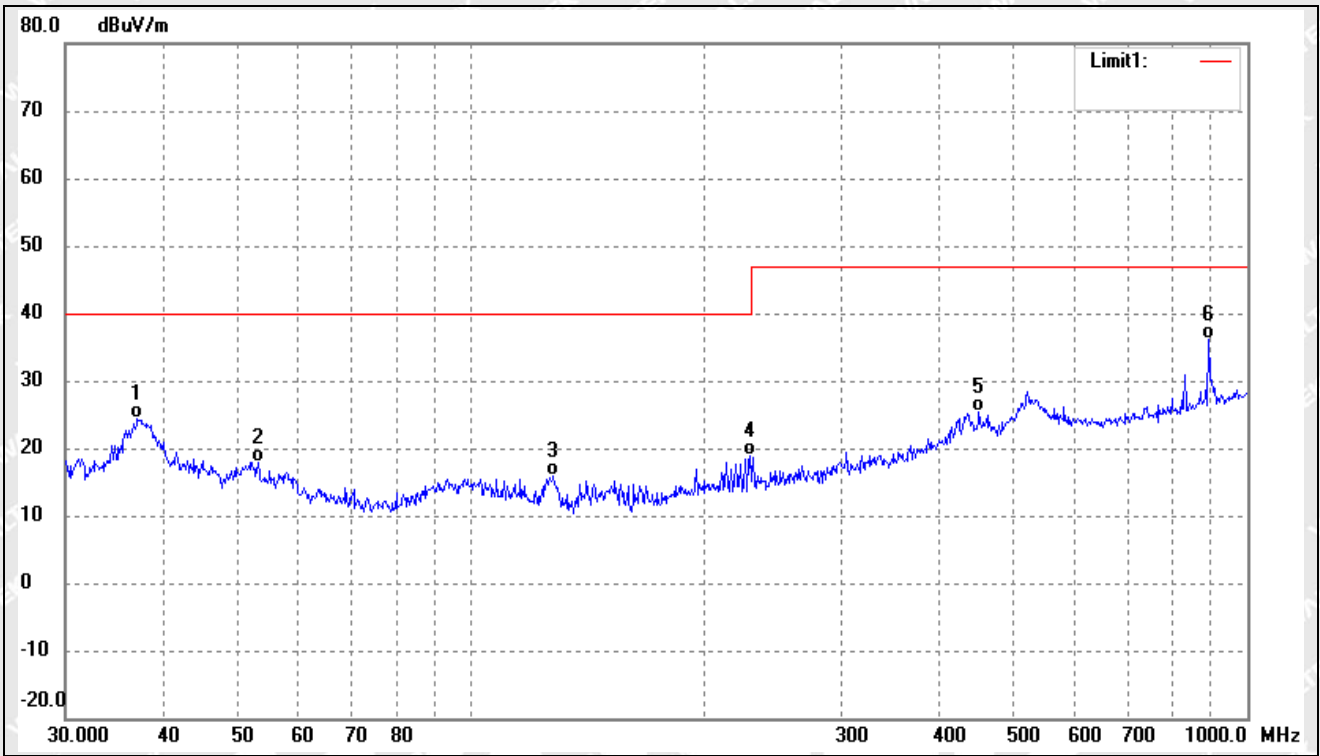
Test mode:	TM1	Polarity:	Horizontal
------------	-----	-----------	------------



No.	Frequency (MHz)	Reading (dBuV/m)	Correct (dB/m)	Result (dBuV/m)	Limit (dBuV/m)	Margin (dB)	Degree ()	Height (cm)	Remark
1	40.4172	25.77	-10.91	14.86	40.00	-25.14	-	-	QP
2	57.7962	27.43	-12.40	15.03	40.00	-24.97	-	-	QP
3	127.6645	28.43	-14.60	13.83	40.00	-26.17	-	-	QP
4	304.6099	28.64	-9.20	19.44	47.00	-27.56	-	-	QP
5	489.0269	27.10	-5.19	21.91	47.00	-25.09	-	-	QP
6	785.0935	26.57	-1.64	24.93	47.00	-22.07	-	-	QP



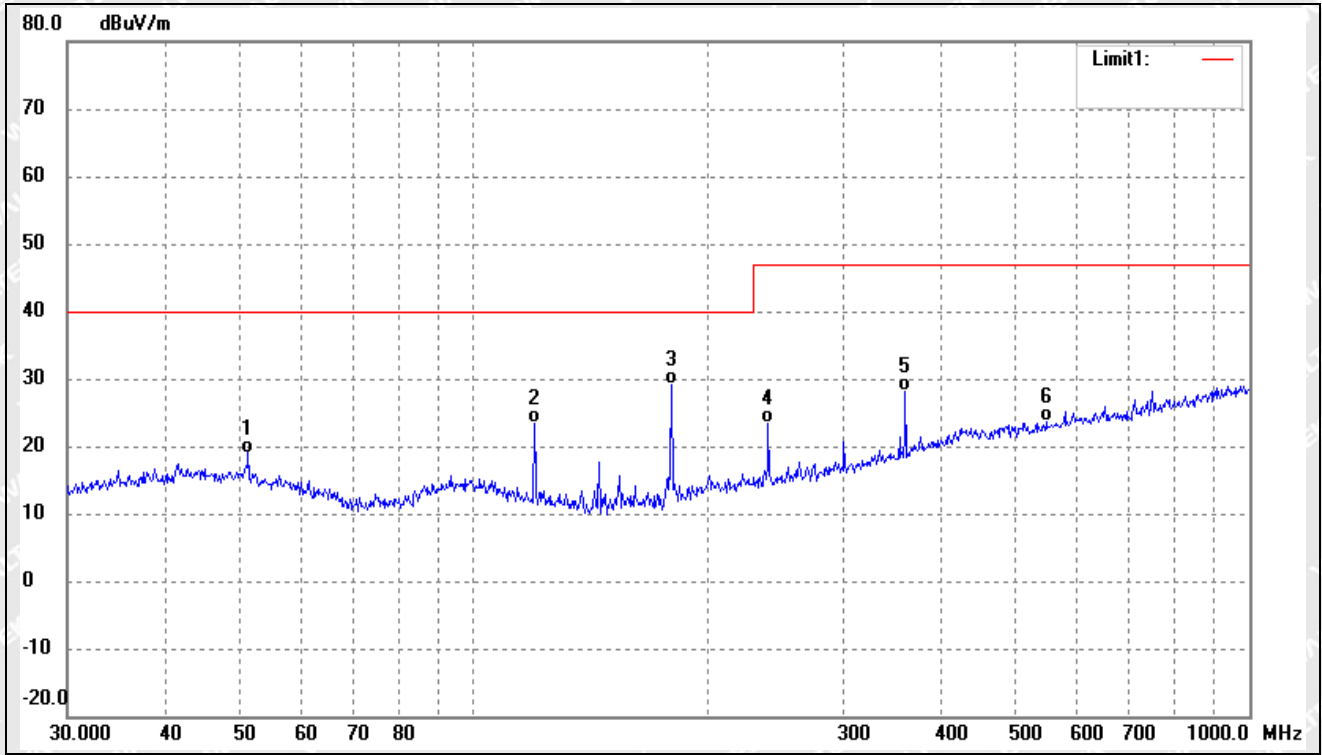
Test mode:	TM1	Polarity:	Vertical
------------	-----	-----------	----------



No.	Frequency (MHz)	Reading (dBuV/m)	Correct (dB/m)	Result (dBuV/m)	Limit (dBuV/m)	Margin (dB)	Degree ()	Height (cm)	Remark
1	37.1550	35.90	-11.41	24.49	40.00	-15.51	-	-	QP
2	53.1313	29.42	-11.50	17.92	40.00	-22.08	-	-	QP
3	127.6645	30.44	-14.60	15.84	40.00	-24.16	-	-	QP
4	228.4904	30.44	-11.55	18.89	40.00	-21.11	-	-	QP
5	451.1350	30.95	-5.45	25.50	47.00	-21.50	-	-	QP
6	890.7278	35.92	0.30	36.22	47.00	-10.78	-	-	QP



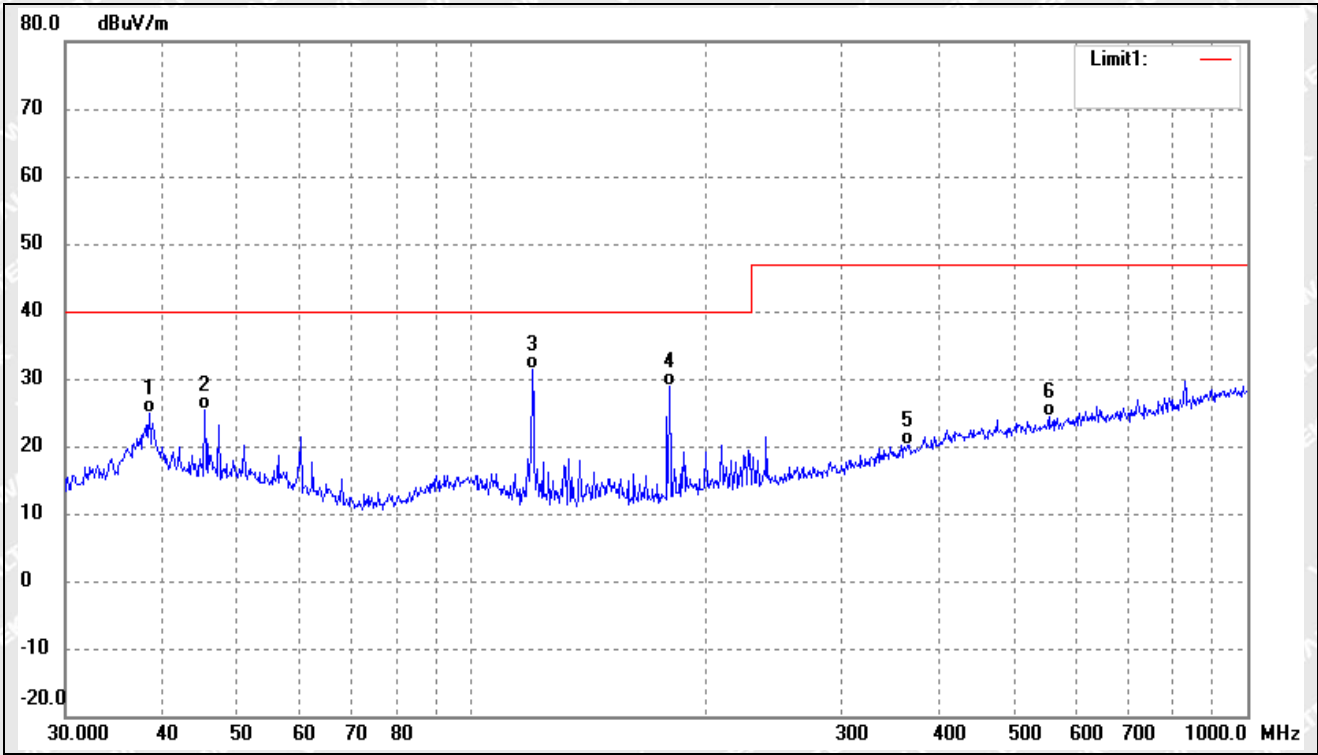
Test mode:	TM2	Polarity:	Horizontal
------------	-----	-----------	------------



No.	Frequency (MHz)	Reading (dBuV/m)	Correct (dB/m)	Result (dBuV/m)	Limit (dBuV/m)	Margin (dB)	Degree ()	Height (cm)	Remark
1	51.3005	30.14	-11.14	19.00	40.00	-21.00	-	-	QP
2	119.8556	37.36	-13.91	23.45	40.00	-16.55	-	-	QP
3	180.0165	43.16	-14.02	29.14	40.00	-10.86	-	-	QP
4	239.9874	34.51	-11.21	23.30	47.00	-23.70	-	-	QP
5	360.4476	35.55	-7.50	28.05	47.00	-18.95	-	-	QP
6	547.0977	28.31	-4.72	23.59	47.00	-23.41	-	-	QP



Test mode:	TM2	Polarity:	Vertical
------------	-----	-----------	----------

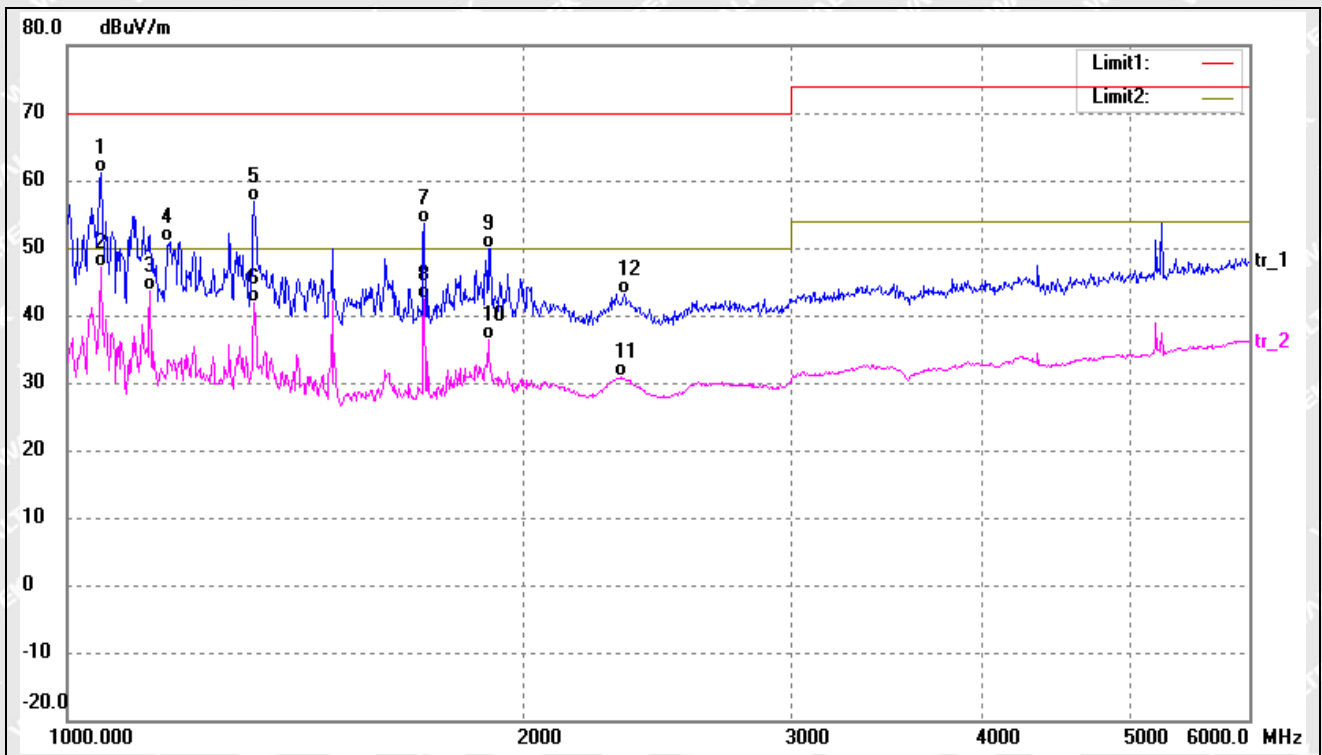


No.	Frequency (MHz)	Reading (dBuV/m)	Correct (dB/m)	Result (dBuV/m)	Limit (dBuV/m)	Margin (dB)	Degree ()	Height (cm)	Remark
1	38.4809	35.95	-11.17	24.78	40.00	-15.22	-	-	QP
2	45.3755	36.26	-10.89	25.37	40.00	-14.63	-	-	QP
3	119.8556	45.35	-13.91	31.44	40.00	-8.56	-	-	QP
4	180.0165	42.96	-14.02	28.94	40.00	-11.06	-	-	QP
5	364.2595	27.60	-7.36	20.24	47.00	-26.76	-	-	QP
6	554.8254	28.90	-4.59	24.31	47.00	-22.69	-	-	QP



➤ Above 1GHz

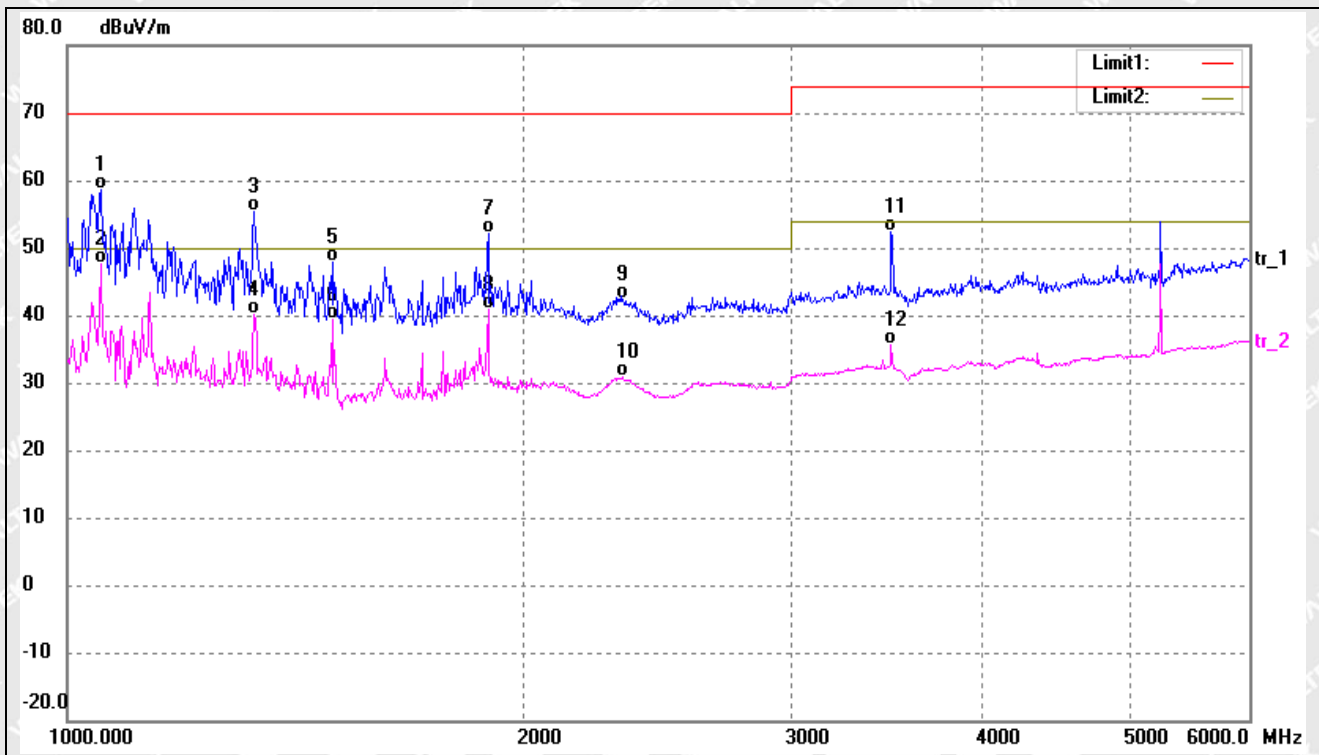
Test mode:	TM1(worst case)	Polarity:	Horizontal
------------	-----------------	-----------	------------



No.	Frequency (MHz)	Reading (dBuV/m)	Correct (dB/m)	Result (dBuV/m)	Limit (dBuV/m)	Margin (dB)	Degree ()	Height (cm)	Remark
1	1051.449	75.93	-14.92	61.01	70.00	-8.99	-	-	QP
2	1051.449	62.06	-14.92	47.14	50.00	-2.86	-	-	AVG
3	1133.628	58.03	-14.52	43.51	50.00	-6.49	-	-	AVG
4	1168.689	65.22	-14.33	50.89	70.00	-19.11	-	-	QP
5	1327.235	70.42	-13.54	56.88	70.00	-13.12	-	-	QP
6	1327.235	55.35	-13.54	41.81	50.00	-8.19	-	-	AVG
7	1717.915	65.73	-12.05	53.68	70.00	-16.32	-	-	QP
8	1717.915	54.53	-12.05	42.48	50.00	-7.52	-	-	AVG
9	1892.439	61.37	-11.54	49.83	70.00	-20.17	-	-	QP
10	1892.439	47.86	-11.54	36.32	50.00	-13.68	-	-	AVG
11	2312.995	41.56	-10.80	30.76	50.00	-19.24	-	-	AVG
12	2325.462	53.94	-10.79	43.15	70.00	-26.85	-	-	QP



Test mode:	TM1(worst case)	Polarity:	Vertical
------------	-----------------	-----------	----------



No.	Frequency (MHz)	Reading (dBuV/m)	Correct (dB/m)	Result (dBuV/m)	Limit (dBuV/m)	Margin (dB)	Degree ()	Height (cm)	Remark
1	1051.449	73.44	-14.92	58.52	70.00	-11.48	-	-	QP
2	1051.449	62.48	-14.92	47.56	50.00	-2.44	-	-	AVG
3	1327.235	68.89	-13.54	55.35	70.00	-14.65	-	-	QP
4	1327.235	53.59	-13.54	40.05	50.00	-9.95	-	-	AVG
5	1493.846	60.61	-12.69	47.92	70.00	-22.08	-	-	QP
6	1493.846	52.02	-12.69	39.33	50.00	-10.67	-	-	AVG
7	1892.439	63.72	-11.54	52.18	70.00	-17.82	-	-	QP
8	1892.439	52.35	-11.54	40.81	50.00	-9.19	-	-	AVG
9	2321.299	53.14	-10.80	42.34	70.00	-27.66	-	-	QP
10	2321.299	41.62	-10.80	30.82	50.00	-19.18	-	-	AVG
11	3486.354	60.79	-8.37	52.42	74.00	-21.58	-	-	QP
12	3486.354	44.02	-8.37	35.65	54.00	-18.35	-	-	AVG

Remark: '-' Means' the test Degree and Height are not recorded by the test software and only show the worst case in the test report.

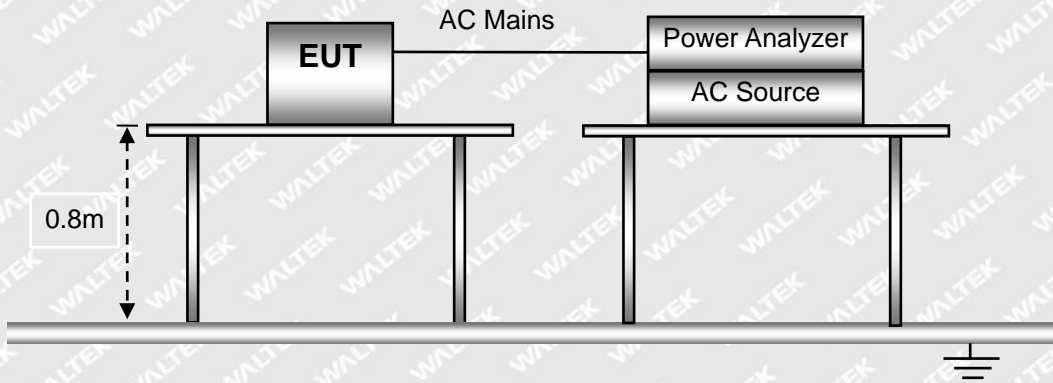


5. Harmonic Current Emissions

5.1 Test Procedure

Test is conducting under the description of EN 61000-3-2.

5.2 Test Setup Block Diagram



5.3 Test Standards

EN61000-3-2, Clause 7.1 Limits for Class A equipment.

5.4 Environmental Conditions

Temperature:	24 °C
Relative Humidity:	55%
ATM Pressure:	1010 mbar

5.5 Harmonic Current Emissions Test Data



Harmonics – Class-A per IEC 61000-3-2:2018/AMD1:2020(Run time)

Test category: Class-A (European limits)

Test Margin: 100

Test date: 2022/5/23

Start time: 11:09:42

End time: 11:12:23

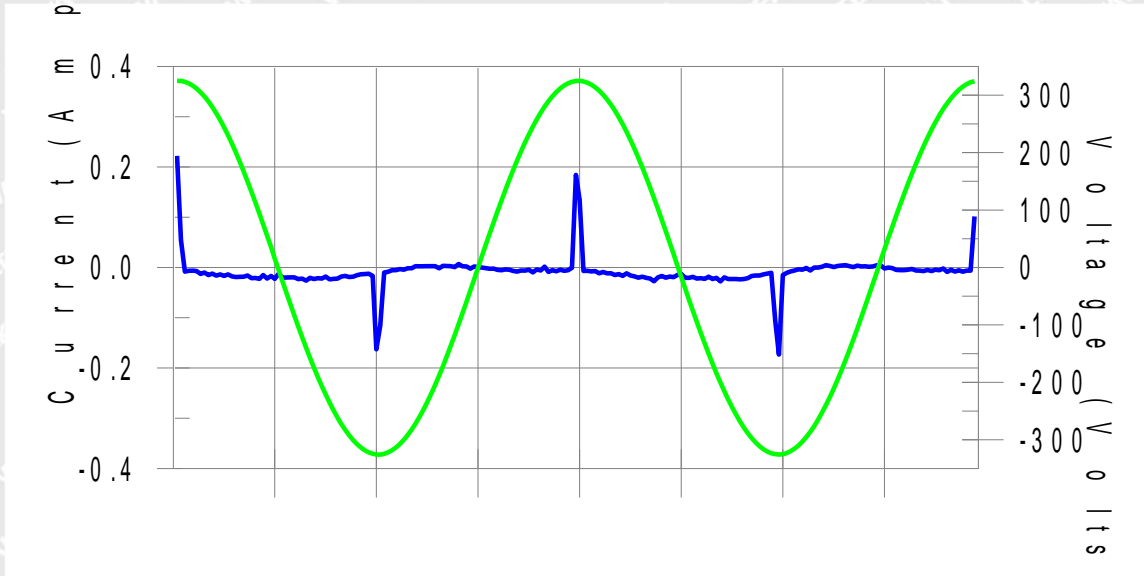
Test duration (min): 2.5

Data file name: H-000383.cts_data

Test Result: Pass

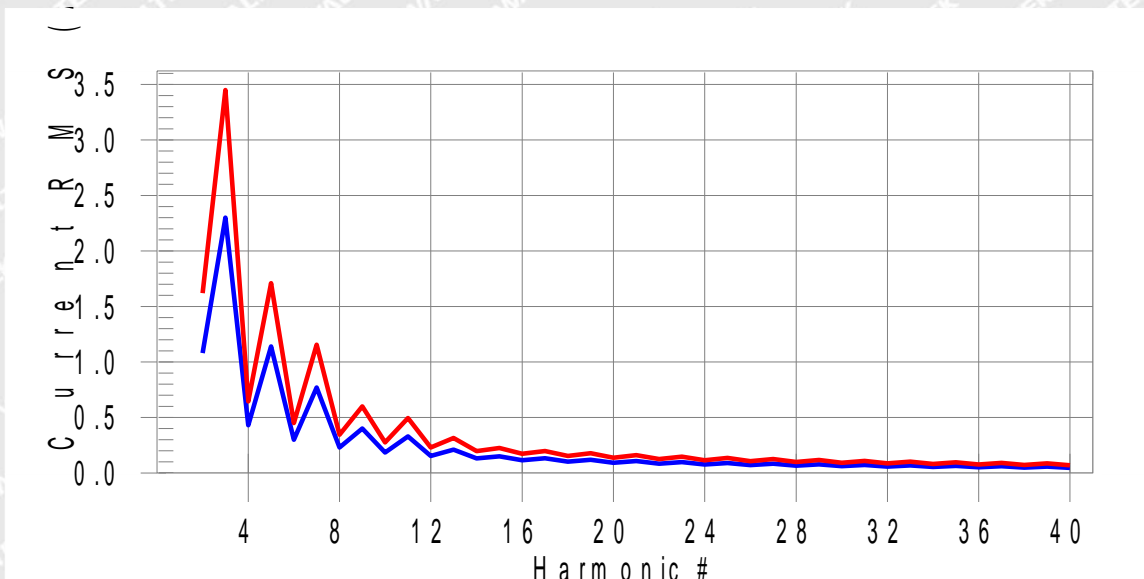
Source qualification: Normal

Current & voltage waveforms



Harmonics and Class A limit line

European Limits



Test result: Pass **Worst harmonics H27-4.2% of 150% limit, H27-6.3% of 100% limit**



Current Test Result Summary (Run time)

Test category: Class-A (European limits) Test Margin: 100
 Test date: 2022/5/23 Start time: 11:09:42 End time: 11:12:23
 Test duration (min): 2.5 Data file name: H-000383.cts_data

Test Result: Pass Source qualification: Normal
 THC(A): 0.027 I-THD(%): 236.5 POHC(A): 0.015 POHC Limit(A): 0.251

Highest parameter values during test:

V_RMS (Volts): 230.14 Frequency(Hz): 50.00
 I_Peak (Amps): 0.222 I_RMS (Amps): 0.032
 I_Fund (Amps): 0.011 Crest Factor: 7.078
 Power (Watts): 2.0 Power Factor: 0.287

Harm#	Harms(avg)	100%Limit	%of Limit	Harms(max)	150%Limit	%of Limit	Status
2	0.001	1.080	N/A	0.001	1.620	N/A	Pass
3	0.008	2.300	0.4	0.009	3.450	0.3	Pass
4	0.001	0.430	N/A	0.001	0.645	N/A	Pass
5	0.008	1.140	0.7	0.008	1.710	0.5	Pass
6	0.001	0.300	N/A	0.001	0.450	N/A	Pass
7	0.008	0.770	1.0	0.008	1.155	0.7	Pass
8	0.001	0.230	N/A	0.001	0.345	N/A	Pass
9	0.008	0.400	1.9	0.008	0.600	1.3	Pass
10	0.001	0.184	N/A	0.001	0.276	N/A	Pass
11	0.008	0.330	2.3	0.008	0.495	1.5	Pass
12	0.001	0.153	N/A	0.001	0.230	N/A	Pass
13	0.007	0.210	3.5	0.007	0.315	2.4	Pass
14	0.001	0.131	N/A	0.001	0.197	N/A	Pass
15	0.007	0.150	4.8	0.007	0.225	3.2	Pass
16	0.001	0.115	N/A	0.001	0.173	N/A	Pass
17	0.007	0.132	5.2	0.007	0.198	3.5	Pass
18	0.000	0.102	N/A	0.001	0.153	N/A	Pass
19	0.007	0.118	5.5	0.007	0.178	3.8	Pass
20	0.000	0.092	N/A	0.001	0.138	N/A	Pass
21	0.006	0.107	5.8	0.006	0.161	3.9	Pass
22	0.000	0.084	N/A	0.001	0.125	N/A	Pass
23	0.006	0.098	6.1	0.006	0.147	4.1	Pass
24	0.000	0.077	N/A	0.001	0.115	N/A	Pass
25	0.006	0.090	6.2	0.006	0.135	4.2	Pass
26	0.000	0.071	N/A	0.001	0.107	N/A	Pass
27	0.005	0.083	6.3	0.005	0.125	4.2	Pass



Reference No.: WTF22X04082738W003

28	0.000	0.066	N/A	0.001	0.099	N/A	Pass
29	0.005	0.078	N/A	0.005	0.116	N/A	Pass
30	0.000	0.061	N/A	0.001	0.092	N/A	Pass
31	0.004	0.073	N/A	0.005	0.109	N/A	Pass
32	0.000	0.058	N/A	0.001	0.086	N/A	Pass
33	0.004	0.068	N/A	0.004	0.102	N/A	Pass
34	0.000	0.054	N/A	0.001	0.081	N/A	Pass
35	0.004	0.064	N/A	0.004	0.096	N/A	Pass
36	0.000	0.051	N/A	0.000	0.077	N/A	Pass
37	0.003	0.061	N/A	0.003	0.091	N/A	Pass
38	0.000	0.048	N/A	0.000	0.073	N/A	Pass
39	0.003	0.058	N/A	0.003	0.087	N/A	Pass
40	0.000	0.046	N/A	0.000	0.069	N/A	Pass

WALTEK



Voltage Source Verification Data (Run time)

Test category: Class-A (European limits) **Test Margin: 100**
Test date: 2022/5/23 **Start time: 11:09:42** **End time: 11:12:23**
Test duration (min): 2.5 **Data file name: H-000383.cts_data**

Test Result: Pass **Source qualification: Normal**

Highest parameter values during test:

Voltage (Vrms): 230.14	Frequency(Hz): 50.00
I_Peak (Amps): 0.222	I_RMS (Amps): 0.032
I_Fund (Amps): 0.011	Crest Factor: 7.078
Power (Watts): 2.0	Power Factor: 0.287

Harm#	Harmonics V-rms	Limit V-rms	% of Limit	Status
2	0.050	0.460	10.94	OK
3	0.497	2.071	23.98	OK
4	0.074	0.460	16.17	OK
5	0.059	0.920	6.45	OK
6	0.034	0.460	7.46	OK
7	0.025	0.690	3.61	OK
8	0.012	0.460	2.71	OK
9	0.013	0.460	2.93	OK
10	0.007	0.460	1.60	OK
11	0.009	0.230	3.98	OK
12	0.010	0.230	4.40	OK
13	0.016	0.230	6.90	OK
14	0.006	0.230	2.67	OK
15	0.005	0.230	2.33	OK
16	0.008	0.230	3.35	OK
17	0.016	0.230	7.11	OK
18	0.009	0.230	3.93	OK
19	0.010	0.230	4.41	OK
20	0.014	0.230	6.17	OK
21	0.011	0.230	4.88	OK
22	0.004	0.230	1.89	OK
23	0.008	0.230	3.41	OK
24	0.003	0.230	1.22	OK
25	0.009	0.230	3.99	OK
26	0.002	0.230	1.00	OK
27	0.010	0.230	4.15	OK
28	0.004	0.230	1.74	OK



Reference No.: WTF22X04082738W003

29	0.008	0.230	3.67	OK
30	0.003	0.230	1.39	OK
31	0.008	0.230	3.40	OK
32	0.003	0.230	1.23	OK
33	0.007	0.230	3.08	OK
34	0.003	0.230	1.21	OK
35	0.007	0.230	3.09	OK
36	0.003	0.230	1.12	OK
37	0.007	0.230	3.16	OK
38	0.003	0.230	1.12	OK
39	0.008	0.230	3.46	OK
40	0.008	0.230	3.30	OK

WALTEK

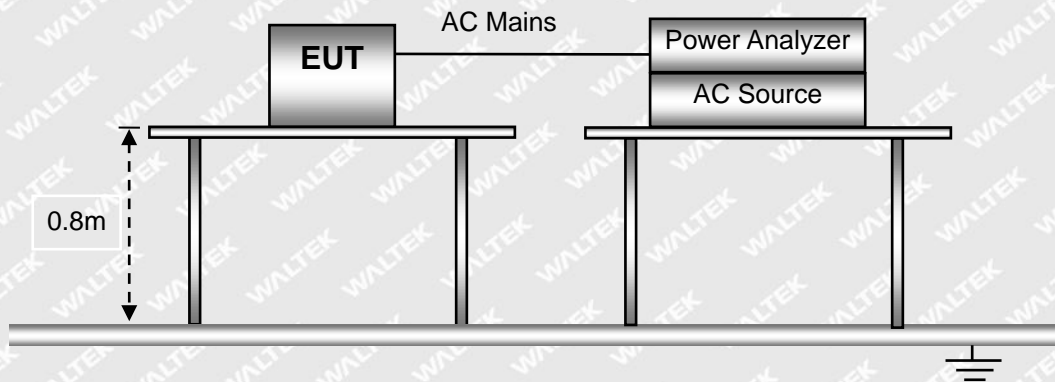


6. Voltage Fluctuation and Flicker

6.1 Test Procedure

Test is conducting under the description of EN 61000-3-3.

6.2 Test Setup Block Diagram



6.3 Test Standards

EN61000-3-3, Limit: Clause 5.

6.4 Environmental Conditions

Temperature:	24°C
Relative Humidity:	55%
ATM Pressure:	1010 mbar

6.5 Voltage Fluctuation and Flicker Test Data



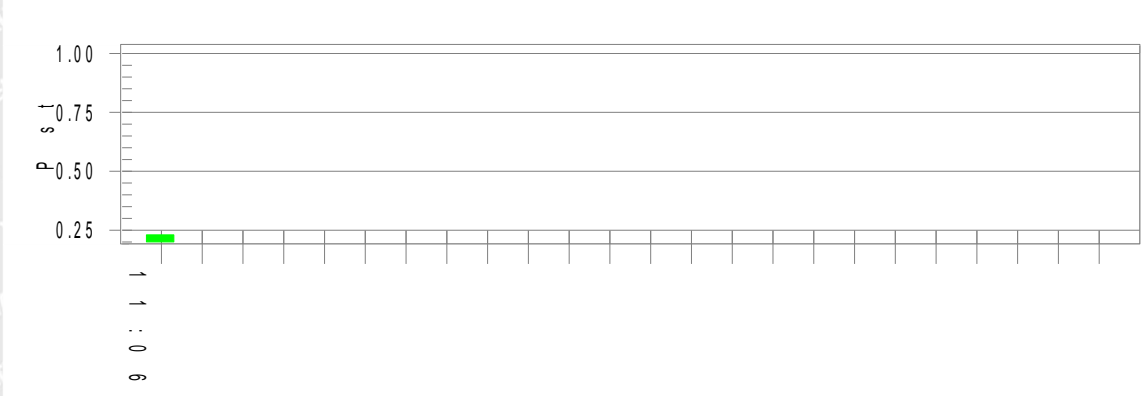
Test mode:	TM1(worst case)
------------	-----------------

Test Result: Pass

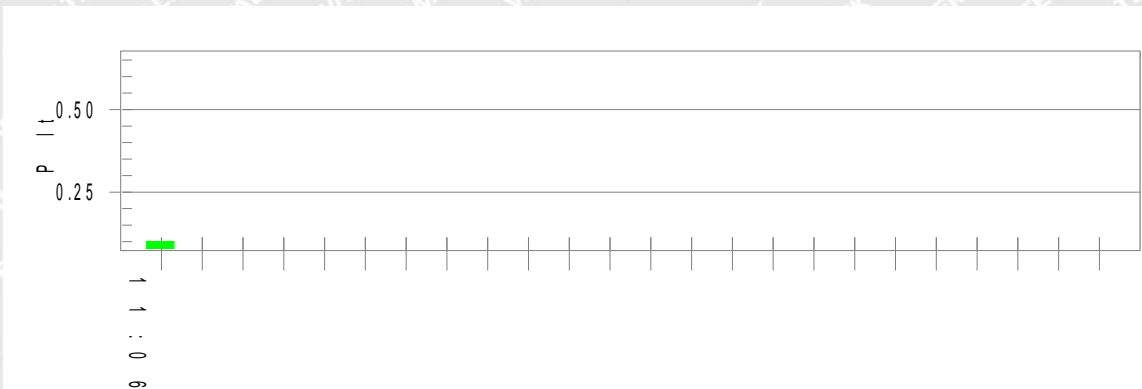
Status: Test Completed

Pst_i and limit line

European Limits



Plt and limit line



Parameter values recorded during the test:

Vrms at the end of test (Volt): 230.10

Highest dt (%):

Test limit (%):

T-max (mS): 0

Test limit (mS): 500.0 Pass

Highest dc (%): 0.00

Test limit (%): 3.30 Pass

Highest dmax (%): 0.00

Test limit (%): 4.00 Pass

Highest Pst (10 min. period): 0.230

Test limit: 1.000 Pass

Highest Plt (2 hr. period): 0.101

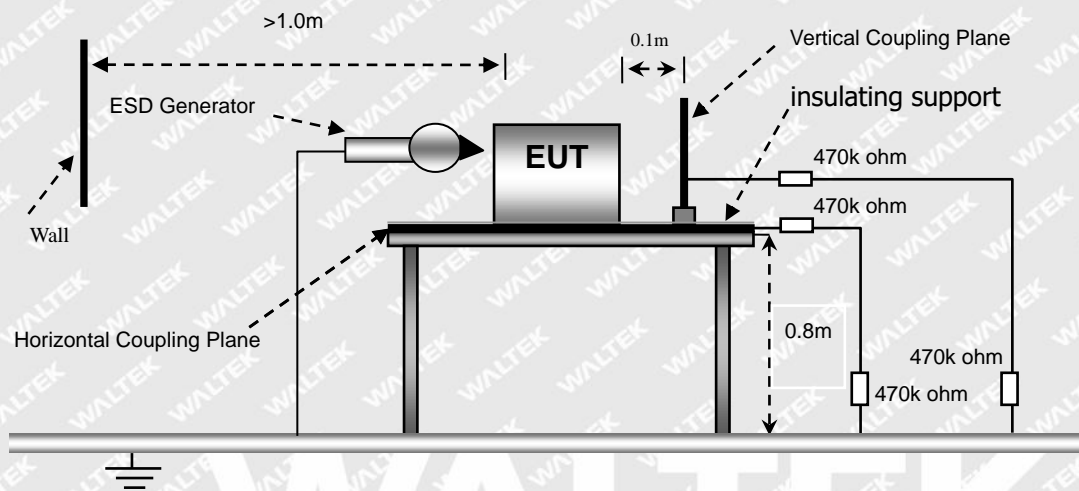
Test limit: 0.650 Pass

7. Electrostatic Discharge (ESD)

7.1 Test Procedure

Test is conducting under the description of EN 61000-4-2.

7.2 Test Setup Block Diagram



7.3 Test Performance

Performance Criterion:	Mode	Verdict
		TM1-TM3

Note: TM3 for TT, TR

7.4 Environmental Conditions

Temperature:	24°C
Relative Humidity:	55%
ATM Pressure:	1010 mbar

7.5 Electrostatic Discharge Immunity Test Data



Test mode	TM1-TM3							
EN 61000-4-2 Test Points	Test Levels (kV)							
	-2	+2	-4	+4	-6	+6	-8	+8
Air Discharge								
USB Port	B	B	B	B	B	B	B	B
Shell Gap	B	B	B	B	B	B	B	B
Button	B	B	B	B	B	B	B	B
Enclosure	B	B	B	B	B	B	B	B
Direct Contact Discharge								
USB Port	B	B	B	B	/	/	/	/
Enclosure	B	B	B	B	/	/	/	/
Indirect Contact Discharge								
HCP (6 Sides)	A	A	A	A	/	/	/	/
VCP (4 Sides)	A	A	A	A	/	/	/	/

Test Result: Pass



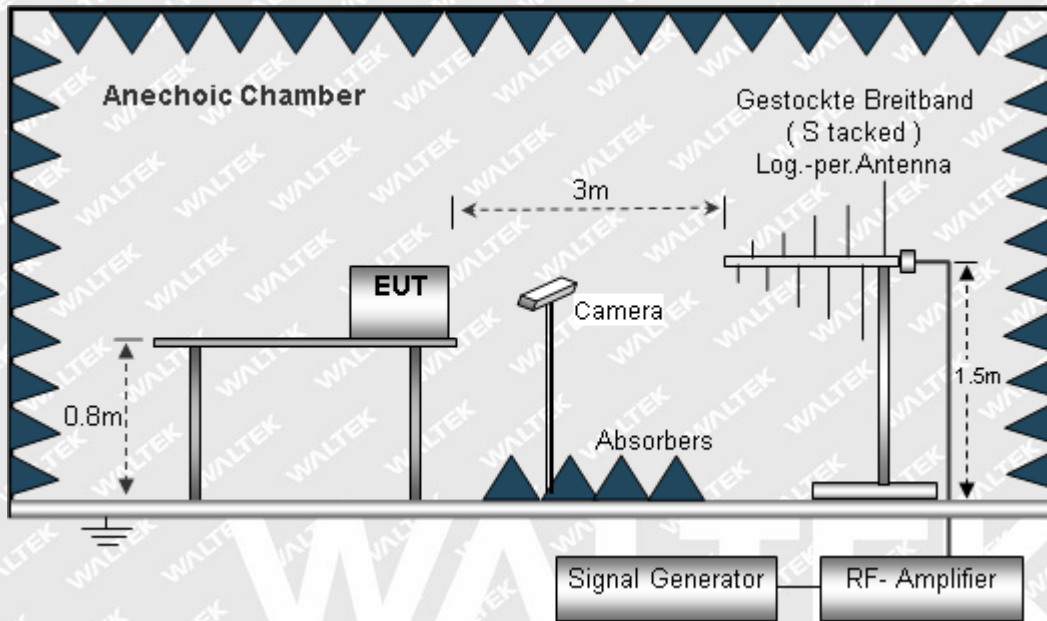


8. Radio Frequency Electromagnetic Field (R/S)

8.1 Test Procedure

Test is conducting under the description of EN 61000-4-3.

8.2 Test Setup Block Diagram



8.3 Test Performance

Performance Criterion:	Mode	Verdict
	TM1-TM3	A

Note: TM3 for CT, CR

8.4 Environmental Conditions

Temperature:	24 °C
Relative Humidity:	55%
ATM Pressure:	1010 mbar

8.5 Continuous Radiated Disturbances Test Data

Frequency step: 1% of fundamental

Dwell time: 1 second

Modulation: AM by 1kHz sine wave with 80% modulation depth



Test mode		TM1-TM3							
Frequency Range(MHz)	Field (V/m)	Front		Rear		Left Side		Right Side	
		VERT	HORI	VERT	HORI	VERT	HORI	VERT	HORI
80-1000	3	A	A	A	A	A	A	A	A
1000-3000	3	A	A	A	A	A	A	A	A
3000-6000	3	A	A	A	A	A	A	A	A

Test Result: Pass

WALTEK

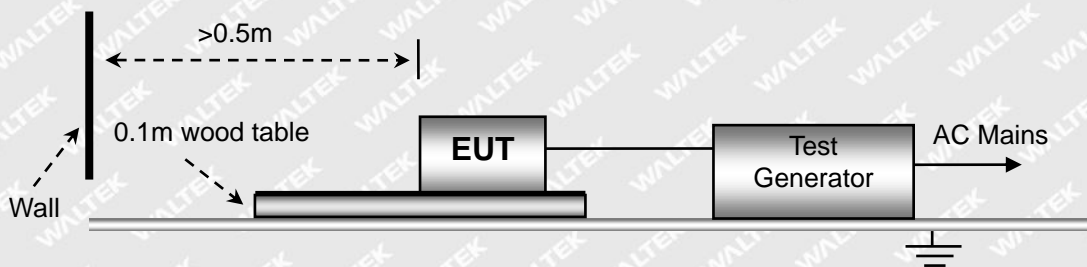
9. Fast Transients, Common Mode (EFT)

9.1 Test Procedure

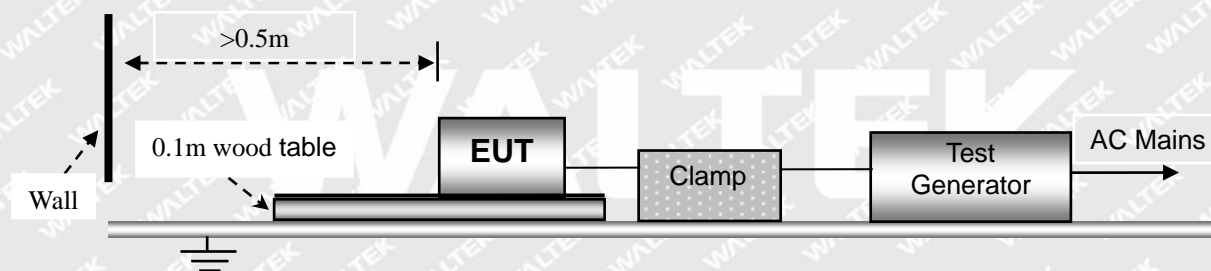
Test is conducting under the description of EN 61000-4-4.

9.2 Test Setup Block Diagram

For AC Mains or DC Ports:



For Signal or Telecommunication Ports:



9.3 Test Performance

Performance Criterion:	Mode	Verdict
		TM1-TM3

Note: TM3 for TT, TR

9.4 Environmental Conditions

Temperature:	23 °C
Relative Humidity:	55%
ATM Pressure:	1010 mbar

9.5 Electrical Fast Transients Test Data



Test Mode		TM1-TM3							
EN 61000-4-4 Test Line		Test Levels (kV)							
		+0.5	-0.5	+1.0	-1.0	+2.0	-2.0	+4.0	-4.0
AC Main Power port	L	A	A	A	A	/	/	/	/
	N	A	A	A	A	/	/	/	/
	PE	/	/	/	/	/	/	/	/
	L-N	A	A	A	A	/	/	/	/
	L-PE	/	/	/	/	/	/	/	/
	N-PE	/	/	/	/	/	/	/	/
	L-N-PE	/	/	/	/	/	/	/	/
Signal ports	/	/	/	/	/	/	/	/	

Test Result: Pass

WALTEK

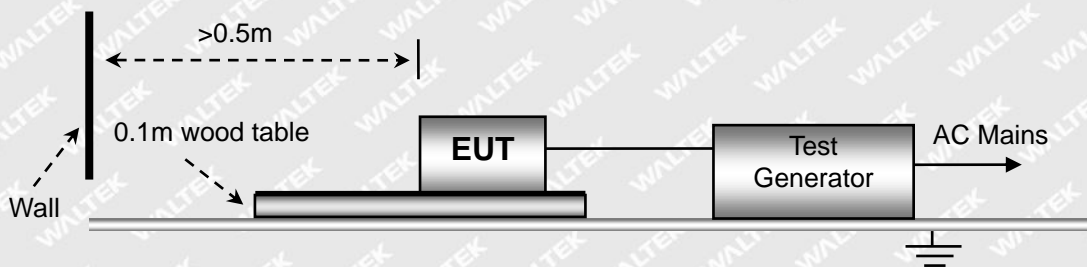
10. Surges

10.1 Test Procedure

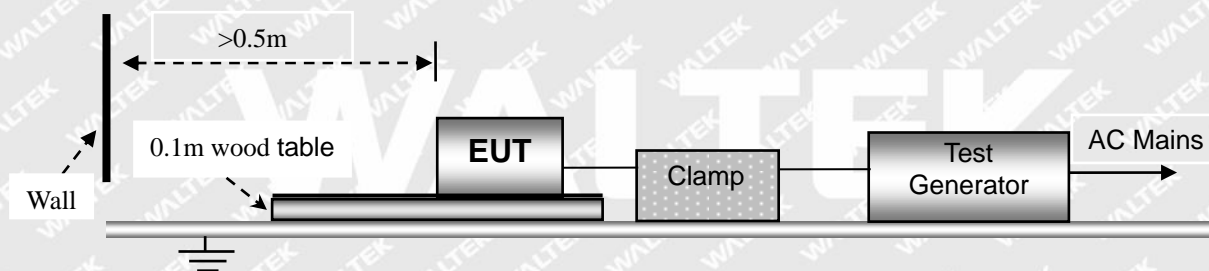
Test is conducting under the description of EN 61000-4-5.

10.2 Test Setup Block Diagram

For AC Mains or DC Ports:



For Signal or Telecommunication Ports:



10.3 Test Performance

Performance Criterion:	Mode	Verdict
		TM1-TM3

Note: TM3 for TT, TR

10.4 Environmental Conditions

Temperature:	24 °C
Relative Humidity:	55%
ATM Pressure:	1010 mbar

10.5 Surge Test Data



Test Mode	TM1-TM4			
Voltage	Poll	Path	Pass	Fail
0.5kV	±	L-N	B	/
1kV	±	L-N	B	/
2kV	±	L-N, L-PE, N-PE	/	/
4kV	±	L-N, L-PE, N-PE	/	/

Test Result: Pass

WALTEK



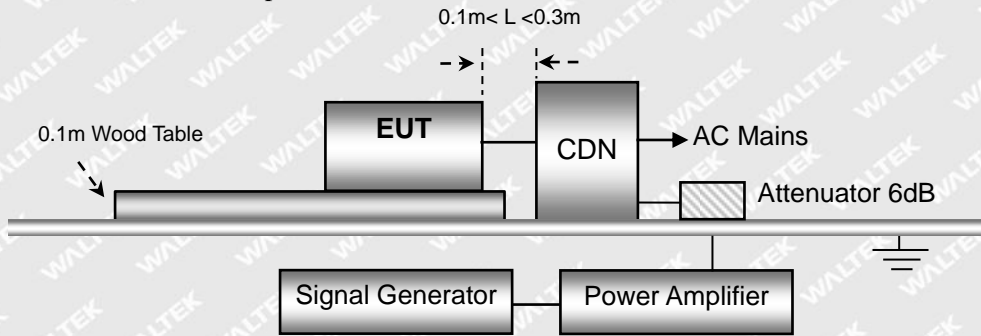
11. Radio Frequency, Common Mode (C/S)

11.1 Test Procedure

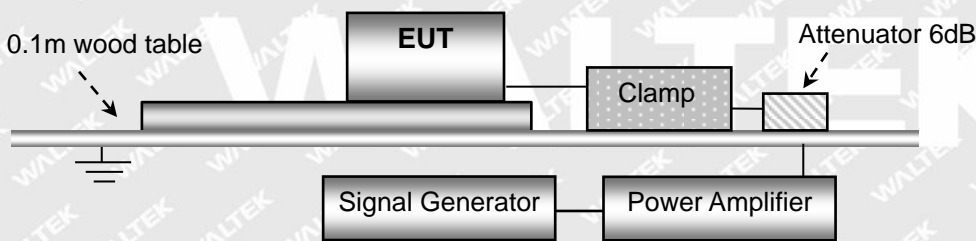
Test is conducting under the description of EN 61000-4-6.

11.2 Test Setup Block Diagram

For AC Mains or DC Input:



For Signal or Telecommunication Ports:



11.3 Test Performance

Performance Criterion:	Mode	Verdict
		TM1-TM3

Note: TM3 for CT, CR

11.4 Environmental Conditions

Temperature:	24 °C
Relative Humidity:	55%
ATM Pressure:	1010 mbar

11.5 Continuous Conducted Disturbances Test Data

Sweep frequency range: 150kHz~80MHz

Frequency step: 1% of fundamental

Dwell time: 1 second



Test Mode		TM1-TM3		
Level	Voltage (V) (rms, unmodulated)	Modulation:	Pass	Fail
1	1	AM 80%, 1kHz sinewave	/	/
2	3	AM 80%, 1kHz sinewave	A	/
3	10	AM 80%, 1kHz sinewave	/	/
X	Special	/	/	/

Test Result: Pass



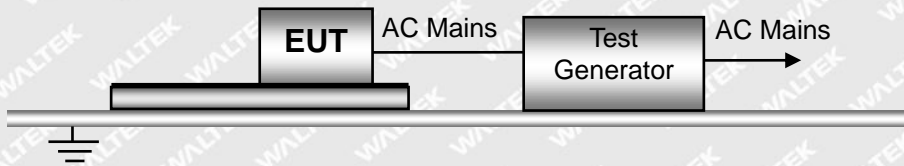


12. Voltage Dips and Interruptions

12.1 Test Procedure

Test is conducting under the description of EN 61000-4-11.

12.2 Test Setup Block Diagram



12.3 Test Performance

Performance Criterion:	Mode	Verdict
	TM1-TM3	B for voltage dip/ C for voltage interruption
Note:TM3 for TT,TR		

12.4 Environmental Conditions

Temperature:	24 °C
Relative Humidity:	55%
ATM Pressure:	1010 mbar

12.5 Voltage Dips And Interruptions Test Data

U: Voltage dips in % U_T (U_T is rated voltage for the EUT)

T: Test duration

Level	U	T	Phase Angle	N	Pass	Fail
1	100%	10ms	0/90/180/270	3	A	/
2	100%	20ms	0/90/180/270	3	B	/
3	30%	500ms	0/90/180/270	3	B	/
4	100%	5000ms	0/90/180/270	3	B	/

Test Result: Pass



EXHIBIT 1 - EUT PHOTOGRAPHS

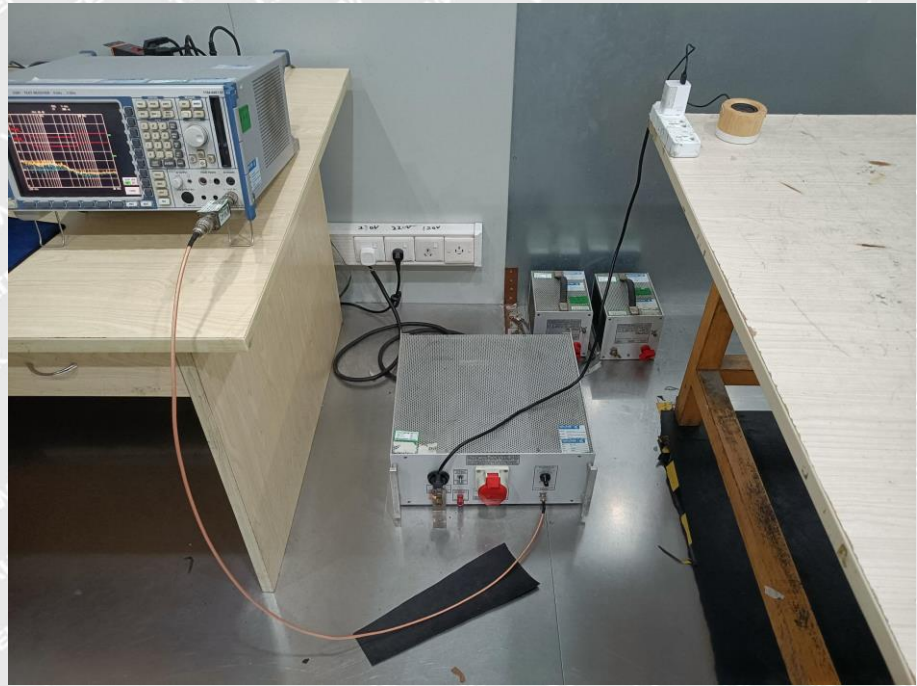
Please refer to “ANNEX”.

WALTEK

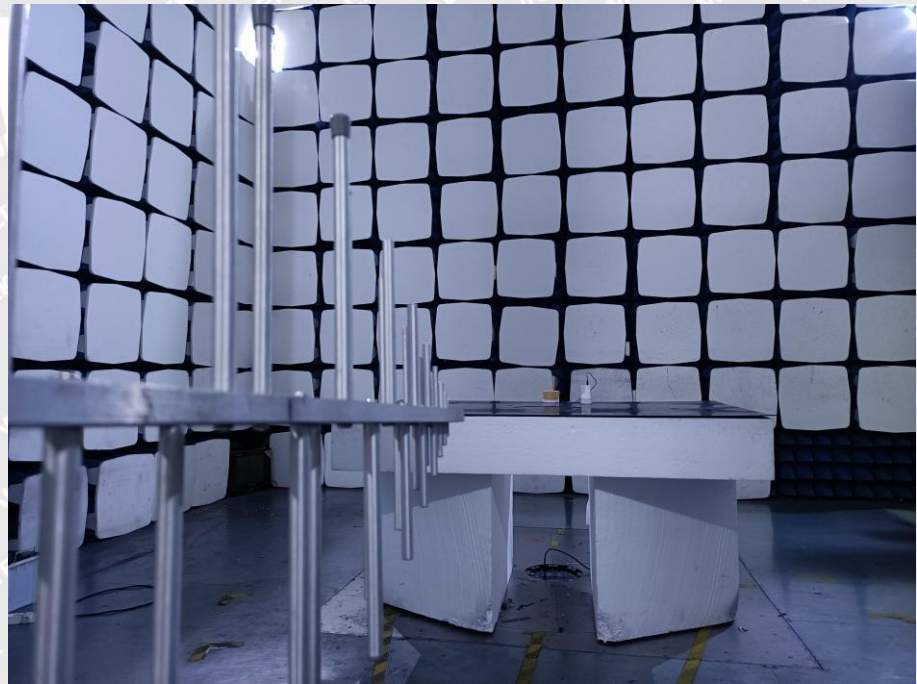


EXHIBIT 2 - TEST SETUP PHOTOGRAPHS

**Conducted Emission
Test Setup**

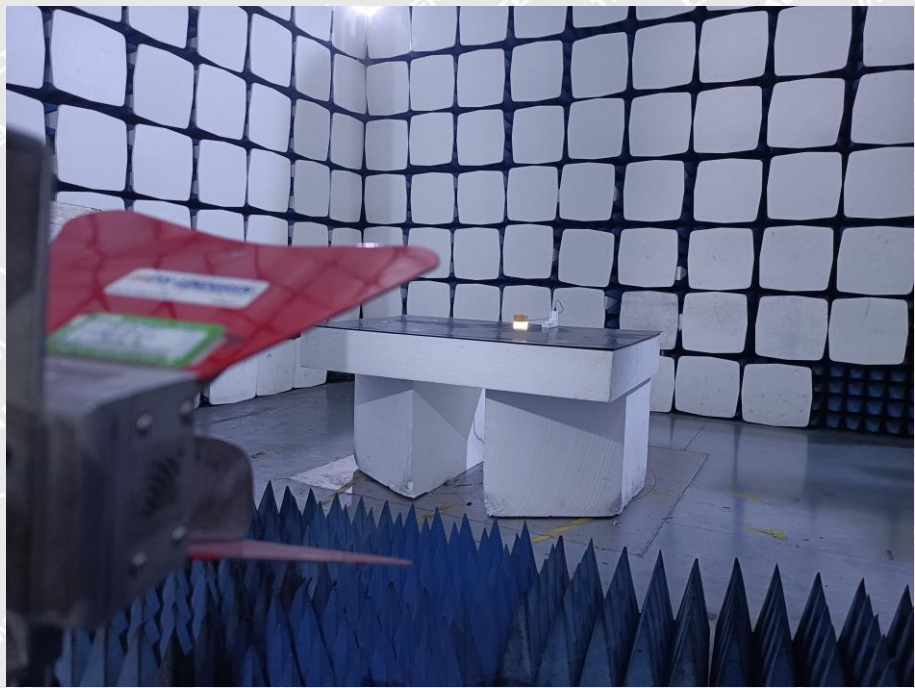


**Radiation Emission Test
View(30MHz to 1GHz)**

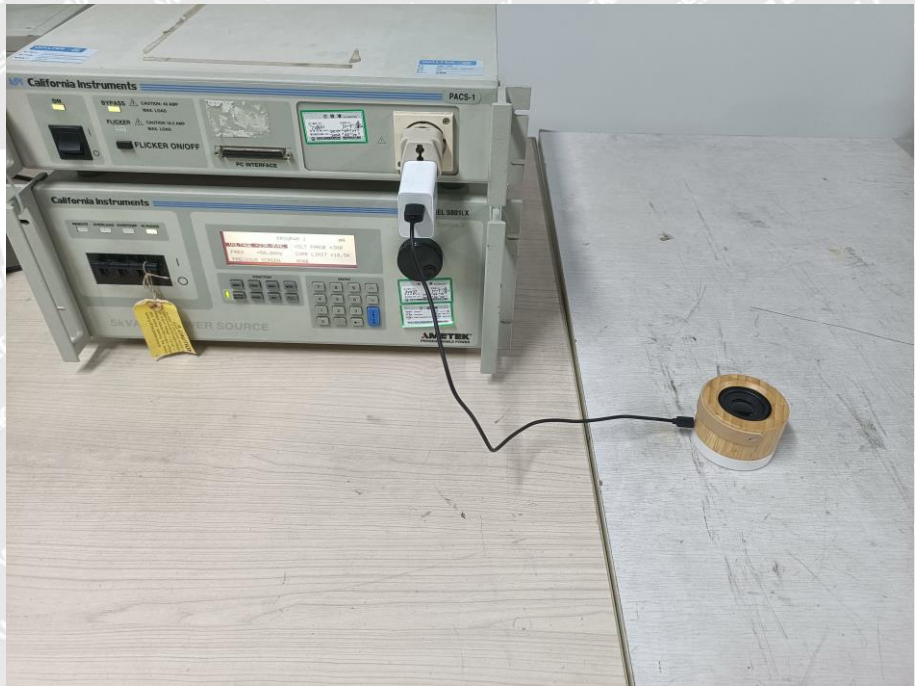




Radiation Emission Test Setup ((Above 1GHz)

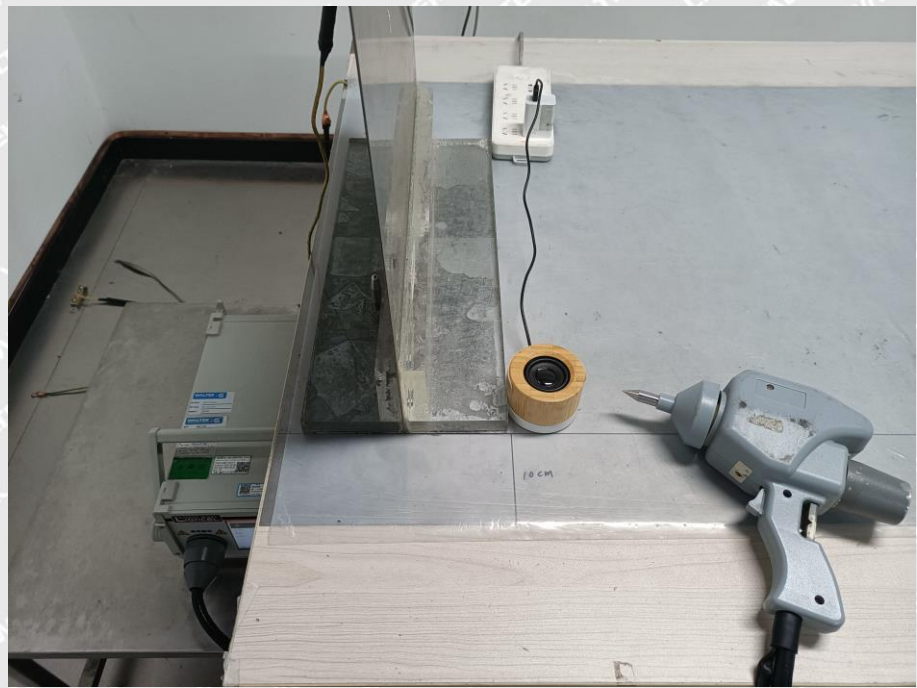


Harmonic/Flicker Test View

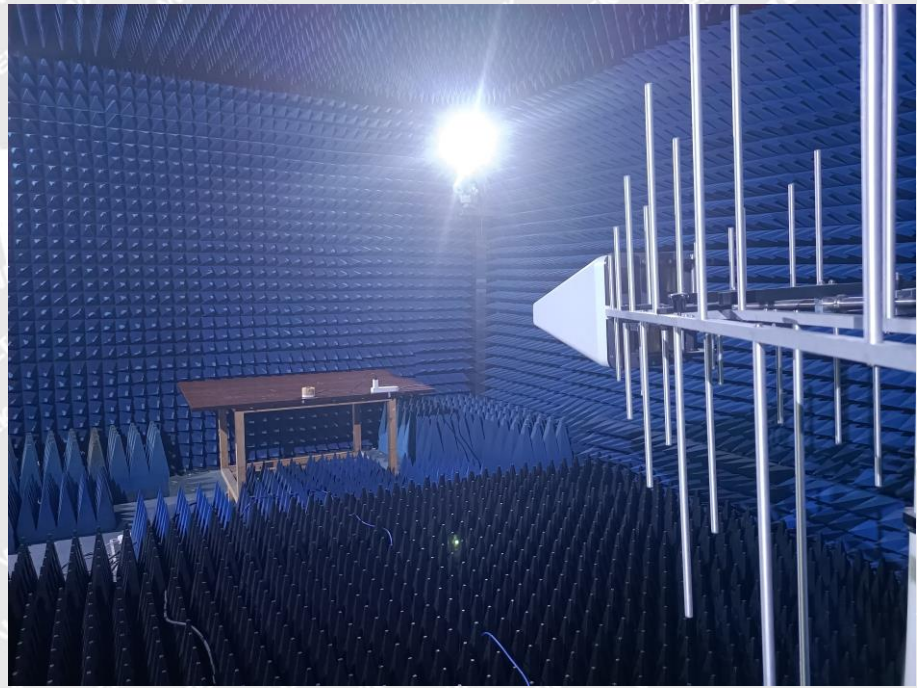




EN 61000-4-2 Test View

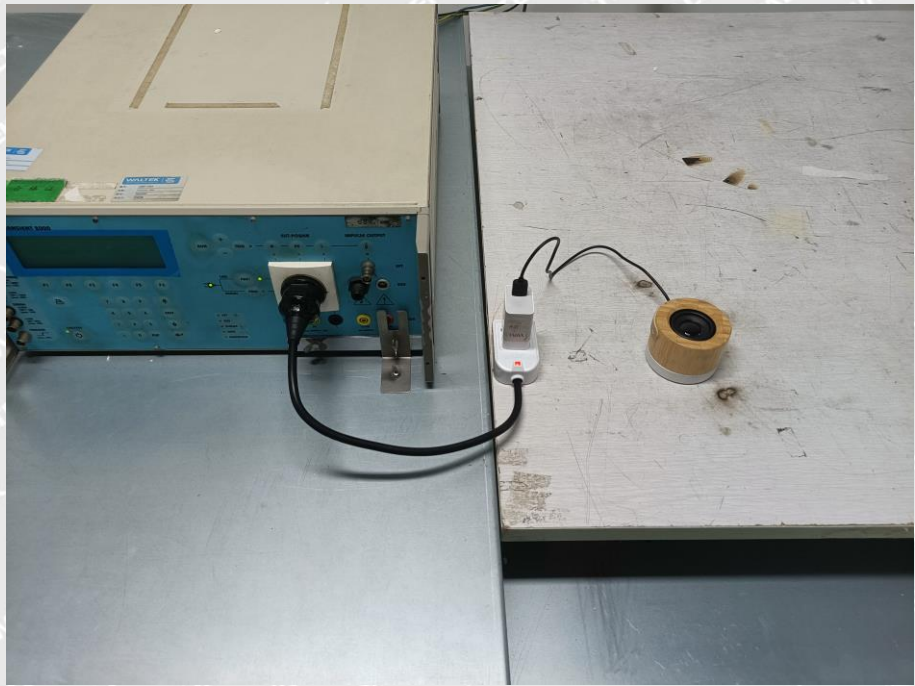


EN 61000-4-3 Test View

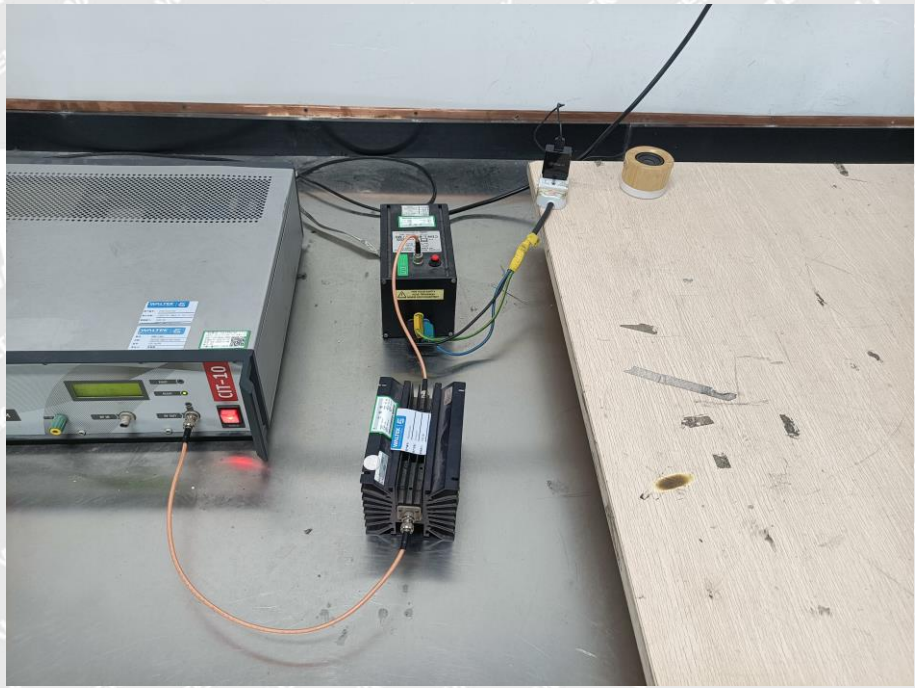




EN 61000-4-4/5/11 Test View



EN 61000-4-6 Test View



***** END OF REPORT *****