



中国认可
国际互认
检测
TESTING
CNAS L3110



TEST REPORT

Reference No. : WTF21D04041016W003
Manufacturer* : Mid Ocean Brands B.V.
Address : 7/F., Kings Tower, 111 King Lam Street, Cheung Sha Wan, Kowloon, Hong Kong
Factory : 116266
Product : RABS 3W round wireless speaker
Model(s) : MO6251
Standards : ETSI EN 301 489-1 V2.2.3 (2019-11)
ETSI EN 301 489-17 V3.1.1 (2017-02)
Date of Receipt sample : 2021-04-28
Date of Test : 2021-04-28 to 2021-05-26
Date of Issue : 2021-05-26
Test Result : **Pass**

Remarks:

1. The results shown in this test report refer only to the sample(s) tested, this test report cannot be reproduced, except in full, without prior written permission of the company. The report would be invalid without specific stamp of test institute and the signatures of compiler and approver.
2. “*” **manufacturer** means any natural or legal person who manufactures radio equipment or has radio equipment designed or manufactured, and markets that equipment under his name or trade mark.

Prepared By:

Waltek Testing Group Co., Ltd.

Address: No. 77, Houjie Section, Guantai Road, Houjie Town, Dongguan City, Guangdong, China

Tel: +86-769-2267 6998

Fax: +86-769-2267 6828

Compiled by:

Andy Feng / Project Engineer

Approved by:

Ford Wang / Designated Reviewer



2 Contents

	Page
1 COVER PAGE	1
2 CONTENTS	2
3 REVISION HISTORY	3
4 GENERAL INFORMATION	4
4.1 GENERAL DESCRIPTION OF E.U.T.	4
4.2 DETAILS OF E.U.T.	4
4.3 SUBCONTRACTED	4
4.4 ABNORMALITIES FROM STANDARD CONDITIONS	4
5 TEST SUMMARY	5
6 EQUIPMENT USED DURING TEST	6
6.1 EQUIPMENTS LIST	6
6.2 DESCRIPTION OF SUPPORT UNITS	7
6.3 MEASUREMENT UNCERTAINTY	7
6.4 TEST EQUIPMENT CALIBRATION	7
6.5 TEST MODES	7
7 EMC REQUIREMENTS FOR EMISSIONS	8
7.1 RADIATED EMISSIONS	8
7.2 ELECTROSTATIC DISCHARGE(ESD)	14
7.3 RADIATED IMMUNITY(R/S)	16
8 PHOTOGRAPHS – TEST SETUP	18
8.1 PHOTOGRAPH - RADIATED EMISSIONS TEST SETUP	18
8.2 PHOTOGRAPH - RADIATED IMMUNITY TEST SETUP	19
8.3 PHOTOGRAPH - ESD TEST SETUP	19
9 PHOTOGRAPHS OF EUT	20
9.1 EUT – APPEARANCE VIEW MODEL: MO6251	20
9.2 EUT – OPEN VIEW MODEL: MO6251	23



3 Revision History

Test report No.	Date of Receipt sample	Date of Test	Date of Issue	Purpose	Comment	Approved
WTF21D04041016 W003	2021-04-28	2021-04-28 to 2021-05-26	2021-05-26	Original	-	Valid

WALTEK



4 General Information

4.1 General Description of E.U.T.

Product: RABS 3W round wireless speaker
Model(s): MO6251
Remark: N/A

4.2 Details of E.U.T.

Ratings: Input: DC 5V(Supplied by Micro USB port)
Battery 3.7V 300mAh

4.3 Subcontracted

Whether parts of tests for the product have been subcontracted to other labs:

Yes No

If Yes, list the related test items and lab information:

Test Lab: /

Lab address: /

Test items: /

4.4 Abnormalities from Standard Conditions

None.

WALTEK



5 Test Summary

EMC PART		
Test Items	Test Requirement	Result
Conducted Emissions	EN 301 489-17	N/A
Radiated Emissions	EN 301 489-17	PASS
Harmonic Current Emissions	EN 301 489-17	N/A
Voltage Fluctuations and Flicker	EN 301 489-17	N/A
Electrostatic Discharge(ESD)	EN 301 489-17	PASS
Radiated Immunity (R/S)	EN 301 489-17	PASS
Electrical Fast Transients (EFT)	EN 301 489-17	N/A
Surge Immunity	EN 301 489-17	N/A
Conducted Immunity (C/S)	EN 301 489-17	N/A
Voltage Dips and Interruptions	EN 301 489-17	N/A

Remark:
PASS: Test item meets the requirement
N/A: Not Applicable

WALTEK



6 Equipment Used during Test

6.1 Equipments List

3m Semi-anechoic Chamber for Radiation Emissions						
Item	Equipment	Manufacturer	Model No.	Serial No.	Last Calibration Date	Calibration Due Date
1	Spectrum Analyzer	R&S	FSP	100091	2021-04-19	2022-04-18
2	Amplifier	Agilent	8447D	2944A10178	2021-04-19	2022-04-18
3	Active Loop Antenna	Beijing Dazhi	ZN30900A	0703	2021-04-19	2022-04-18
4	Trilog Broadband Antenna	SCHWARZBECK	VULB9163	336	2020-08-22	2021-08-21
5	Coaxial Cable (below 1GHz)	Top	TYPE16(13M)	-	2021-04-19	2022-04-18
6	Broad-band Horn Antenna	SCHWARZBECK	BBHA 9120 D	667	2021-04-24	2022-04-23
7	Broadband Preamplifier	COMPLIANCE DIRECTION	PAP-1G18	2004	2021-04-19	2022-04-18
8	Coaxial Cable (above 1GHz)	Top	1GHz-25GHz	EW02014-7	2021-04-19	2022-04-18
9	Universal Radio Communication Tester	R&S	CMU 200	121315	2021-04-19	2022-04-18
10	Universal Radio Communication Tester	R&S	CMW 500	127818	2021-04-19	2022-04-18
Electrostatic Discharge						
Item	Equipment	Manufacturer	Model No.	Serial No.	Last Calibration Date	Calibration Due Date
1	Electrostatic Discharge Simulator	SCHLODER	SESD 216	606144	2021-04-23	2022-04-22
2	Universal Radio Communication Tester	R&S	CMU 200	112461	2021-04-19	2022-04-18
Radio-frequency electromagnetic fields						
Item	Equipment	Manufacturer	Model No.	Serial No.	Last Calibration Date	Calibration Due Date
1	Signal Generater	R&S	SMB100A	105942	2020-07-30	2021-07-29
2	Power Amplifier	BONN Elektronik	BLWA0830-160/100/40D	128740	2020-07-30	2021-07-29
3	Gestockte Breitband (S tacked) Log.-per.Antenna	SCHWARZBECK	STLP9128D	043	2020-07-30	2021-07-29
4	Power Meter	R&S	NRP2	102031	2021-04-19	2022-04-18
5	Universal Radio Communication Tester	R&S	CMU 200	112461	2021-04-19	2022-04-18



6	Audio Analyzer	R&S	UPV	102011	2020-09-17	2021-09-16
7	Universal Radio Communication Tester	R&S	CMW500	127818	2021-04-19	2022-04-18
3m Semi-anechoic Chamber for Radiation(TDK)						
Item	Equipment	Manufacturer	Model No.	Serial No	Last Calibration Date	Calibration Due Date
1	Test Receiver	R&S	ESCI	101296	2021-04-19	2022-04-18
2	Trilog Broadband Antenna	SCHWARZBECK	VULB9160	9160-3325	2021-04-24	2022-04-23
3	Amplifier	ANRITSU	MH648A	M43381	2021-04-19	2022-04-18
4	Cable	HUBER+SUHNER	CBL2	525178	2021-04-19	2022-04-18
5	Universal Radio Communication Tester	R&S	CMU 200	112461	2021-04-19	2022-04-18
6	Universal Radio Communication Tester	R&S	CMW500	127818	2021-04-19	2022-04-18

6.2 Description of Support Units

Equipment	Manufacturer	Model No.	Series No.
/	/	/	/

6.3 Measurement Uncertainty

Parameter	Uncertainty
Conduction disturbance(150kHz~30MHz)	□3.64dB
Radiated Emission(30MHz~1GHz)	□5.08dB
Radiated Emission(1GHz~6GHz)	□4.99dB

6.4 Test Equipment Calibration

All the test equipments used are valid and calibrated by CEPREI Certification Body that address is No.110 Dongguan Zhuang RD. Guangzhou, P.R.China.

6.5 Test Modes

Radiated Emissions	
TM1	Bluetooth mode
TM2*	Bluetooth mode+Charging
Electrostatic Discharge(ESD)	
TM1	Bluetooth mode
TM2*	Bluetooth mode+Charging
Radiated Immunity(R/S)	
TM1	Bluetooth mode
TM2*	Bluetooth mode+Charging
Note: “*”mean show the worst mode in this report.	



7 EMC Requirements for Emissions

7.1 Radiated Emissions

Test Method	: EN 301 489-1, EN 55032
Frequency Range	: 30MHz to 1GHz, 1GHz to 6GHz
Class/Severity	: Class B/ Table A.4 of EN 55032 (30MHz to 1GHz) Class B/ A.5 of EN 55032 (1GHz to 6GHz)
Detector	: Peak for pre-scan (120kHz Resolution Bandwidth Below 1GHz; 1MHz Resolution Bandwidth Above 1GHz)

7.1.1 EUT Operation:

Operating Environment :	
Temperature	: 22.5°C
Humidity	: 52.5 % RH
Atmospheric Pressure	: 101.2kPa
EUT Operation :	
Refer to section 6.5.	

7.1.2 Test Setup

The radiated emission tests were performed using the setup accordance with the EN 55032.

Frequency Range: Below 1 GHz

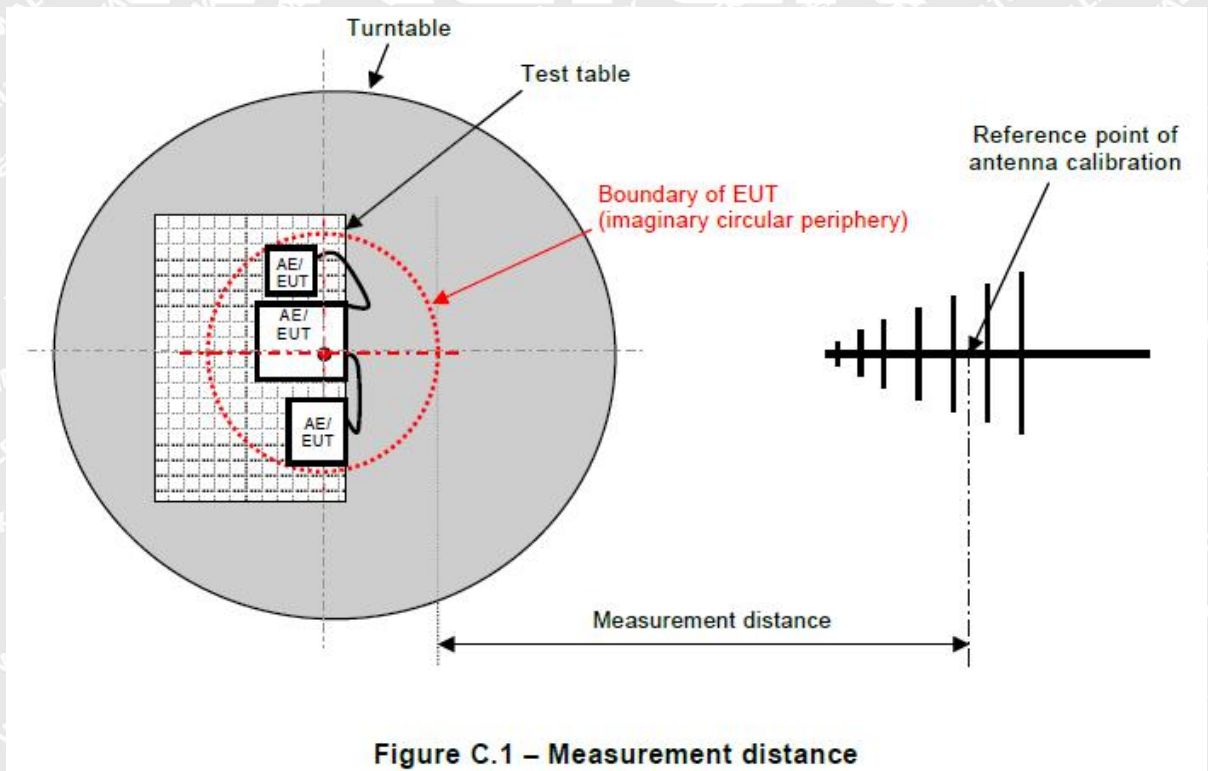
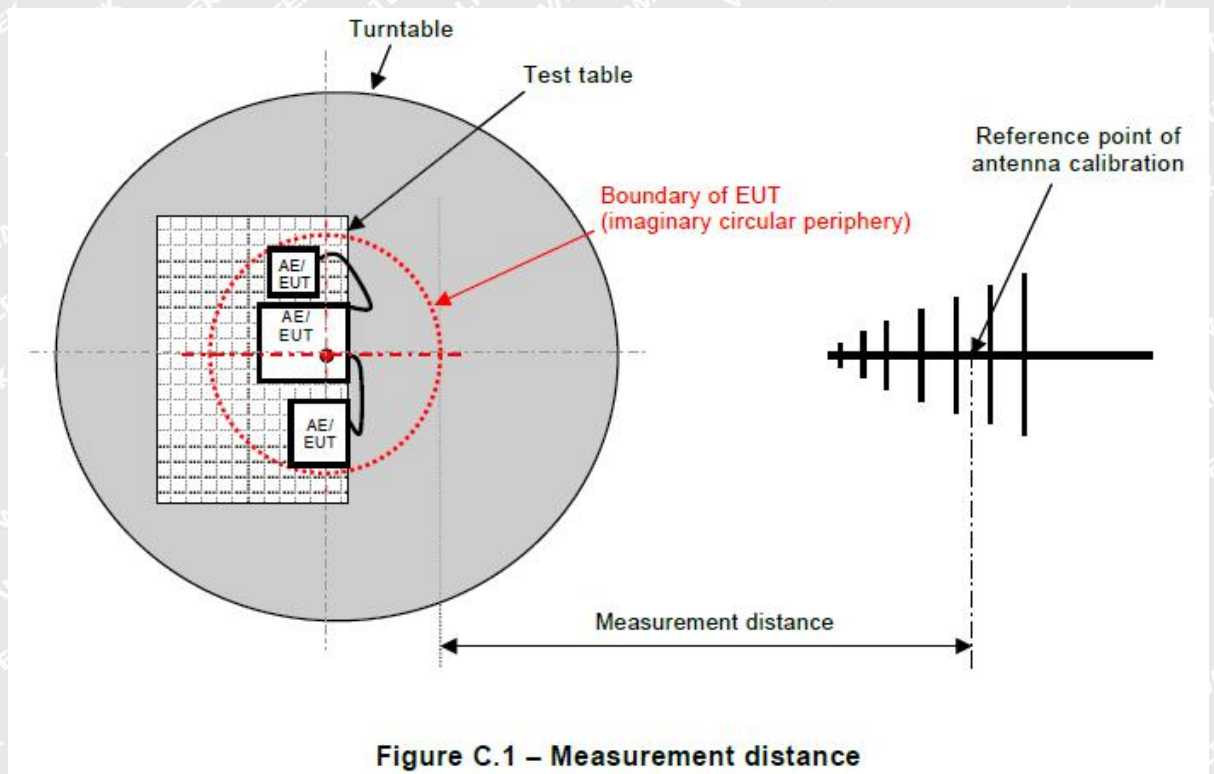

Figure C.1 – Measurement distance



Frequency Range: Above 1 GHz



7.1.3 Corrected Amplitude & Margin Calculation

The Corrected Amplitude is calculated by adding the Antenna Factor and Cable Factor, and subtracting the Amplifier Gain from the Amplitude reading. The basic equation is as follows:

$$\text{Corr. Ampl.} = \text{Indicated Reading} + \text{Antenna Factor} + \text{Cable Factor} - \text{Amplifier Gain}$$

The “Margin” column of the following data tables indicates the degree of compliance with the applicable limit. For example, a margin of -7dB means the emission is 7dB below the maximum limit for Class B. The equation for margin calculation is as follows:

$$\text{Margin} = \text{Corr. Ampl.} - \text{Class B Limit}$$



7.1.4 Test Result

Frequency Range: 30MHz ~ 1000MHz

Antenna Polarization: Horizontal

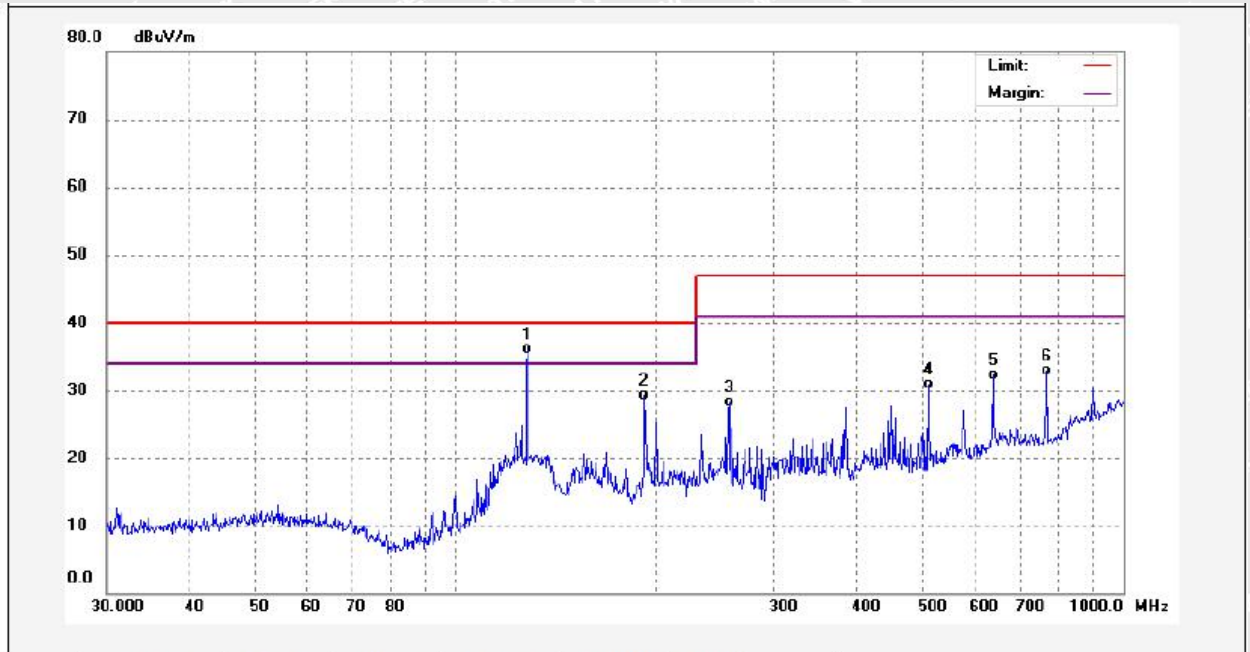

No.	Freq. (MHz)	Reading (dBuV/m)	Factor (dB)	Result (dBuV/m)	Limit (dBuV/m)	Margin (dB)	Detector	Remark
1	128.1127	52.72	-16.62	36.10	40.00	-3.90	QP	
2	191.7450	47.33	-17.97	29.36	40.00	-10.64	QP	
3	256.5210	44.74	-16.40	28.34	47.00	-18.66	QP	
4	510.0434	40.27	-9.42	30.85	47.00	-16.15	QP	
5	638.3686	39.19	-6.96	32.23	47.00	-14.77	QP	
6	768.7481	38.11	-5.24	32.87	47.00	-14.13	QP	



Antenna Polarization: Vertical

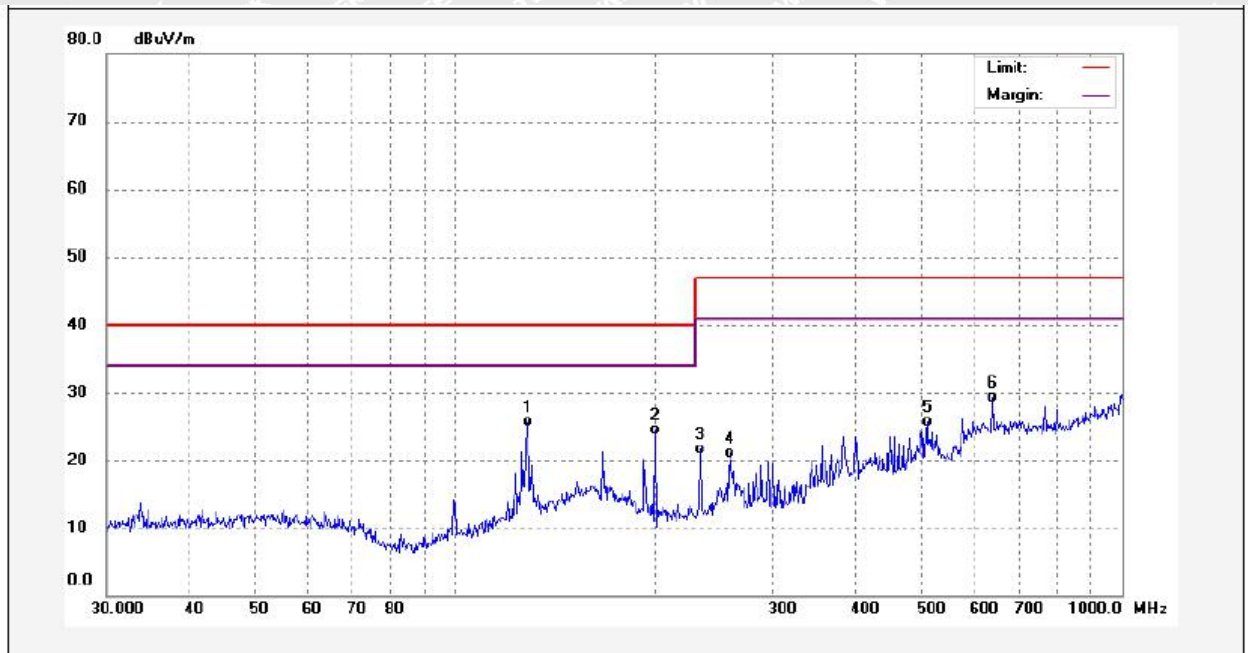

No.	Freq. (MHz)	Reading (dBuV/m)	Factor (dB)	Result (dBuV/m)	Limit (dBuV/m)	Margin (dB)	Detector	Remark
1	128.5629	42.32	-16.59	25.73	40.00	-14.27	QP	
2	199.2855	42.70	-18.23	24.47	40.00	-15.53	QP	
3	233.3486	39.31	-17.60	21.71	47.00	-25.29	QP	
4	258.3263	37.47	-16.33	21.14	47.00	-25.86	QP	
5	510.0434	35.03	-9.42	25.61	47.00	-21.39	QP	
6	640.6109	36.15	-6.91	29.24	47.00	-17.76	QP	



Frequency Range: 1000MHz ~ 6000MHz
Antenna Polarization: Horizontal

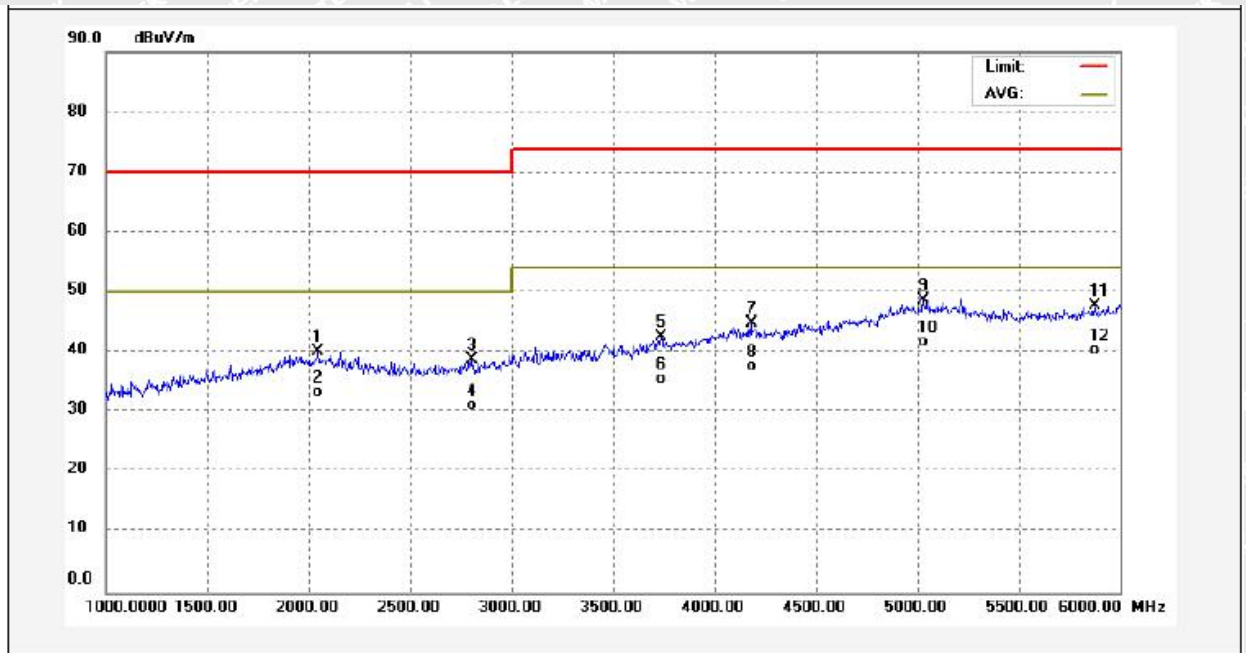

No.	Freq. (MHz)	Reading (dBuV/m)	Factor (dB)	Result (dBuV/m)	Limit dBuV	Margin (dB)	Detector	Remark
1	2045.000	48.66	-8.50	40.16	70.00	-29.84	peak	
2	2045.000	41.82	-8.50	33.32	50.00	-16.68	AVG	
3	2800.000	46.43	-7.57	38.86	70.00	-31.14	peak	
4	2800.000	38.80	-7.57	31.23	50.00	-18.77	AVG	
5	3735.000	49.49	-6.78	42.71	74.00	-31.29	peak	
6	3735.000	42.45	-6.78	35.67	54.00	-18.33	AVG	
7	4180.000	51.17	-6.18	44.99	74.00	-29.01	peak	
8	4180.000	43.86	-6.18	37.68	54.00	-16.32	AVG	
9	5030.000	52.77	-3.99	48.78	74.00	-25.22	peak	
10	5030.000	45.63	-3.99	41.64	54.00	-12.36	AVG	
11	5875.000	50.29	-2.59	47.70	74.00	-26.30	peak	
12	5875.000	42.97	-2.59	40.38	54.00	-13.62	AVG	



Antenna Polarization: Vertical

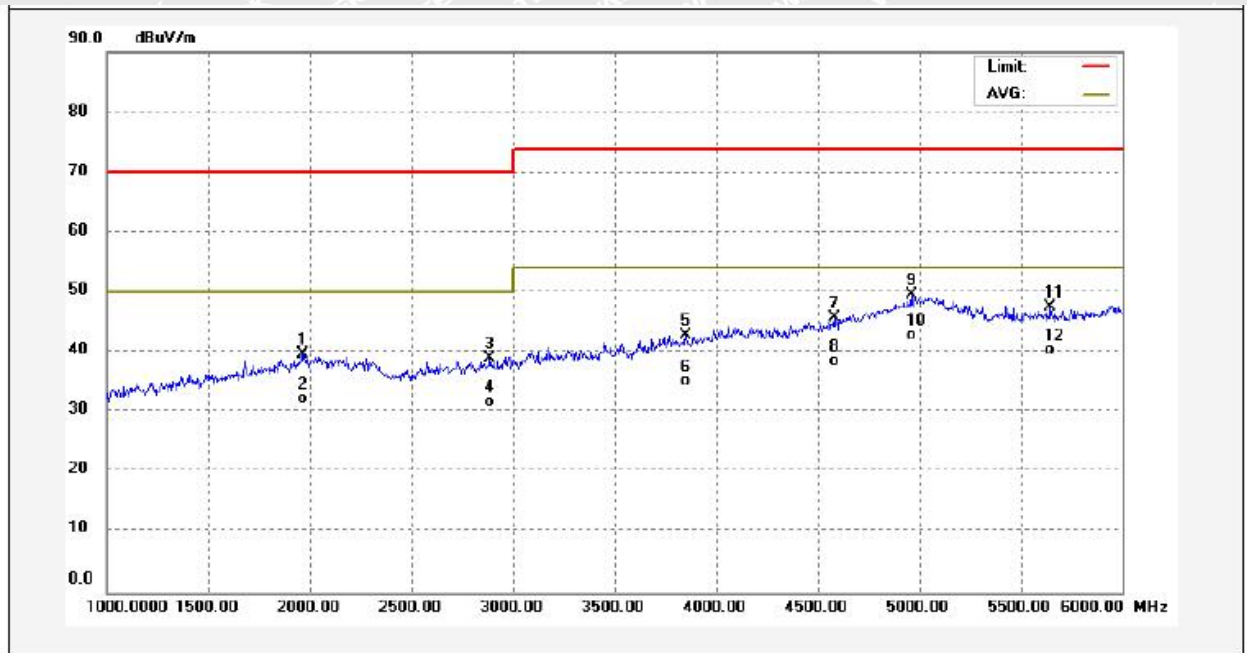

No.	Freq. (MHz)	Reading (dBuV/m)	Factor (dB)	Result (dBuV/m)	Limit dBuV/	Margin (dB)	Detector	Remark
1	1960.000	50.41	-10.64	39.77	70.00	-30.23	peak	
2	1960.000	42.99	-10.64	32.35	50.00	-17.65	AVG	
3	2885.000	50.06	-11.02	39.04	70.00	-30.96	peak	
4	2885.000	42.87	-11.02	31.85	50.00	-18.15	AVG	
5	3850.000	50.43	-7.54	42.89	74.00	-31.11	peak	
6	3850.000	42.80	-7.54	35.26	54.00	-18.74	AVG	
7	4580.000	50.33	-4.65	45.68	74.00	-28.32	peak	
8	4580.000	43.22	-4.65	38.57	54.00	-15.43	AVG	
9	4960.000	51.18	-1.66	49.52	74.00	-24.48	peak	
10	4960.000	44.52	-1.66	42.86	54.00	-11.14	AVG	
11	5645.000	50.31	-2.81	47.50	74.00	-26.50	peak	
12	5645.000	43.17	-2.81	40.36	54.00	-13.64	AVG	



7.2 Electrostatic Discharge(ESD)

Test Method	: EN 301 489-1, EN 61000-4-2
Discharge Impedance	: 330 Ω / 150 pF
Discharge Voltage	: Air Discharge: +/-2,4,8 kV Contact Discharge: +/-2,4 kV HCP & VCP: +/-2,4 kV
Polarity	: Positive & Negative
Discharge Repeat Times	: At Least 20 times at each test point
Discharge Mode	: Single Discharge
Discharge Period	: 1 second minimum

7.2.1 E.U.T. Operation

Operating Environment:

Temperature	: 21.5 \pm C
Humidity	: 52.0 % RH
Barometric Pressure	: 101.3kPa

EUT Operation:

Refer to section 6.5.

7.2.2 Block Diagram of Setup

The ESD test was performed in accordance with the EN 61000-4-2.

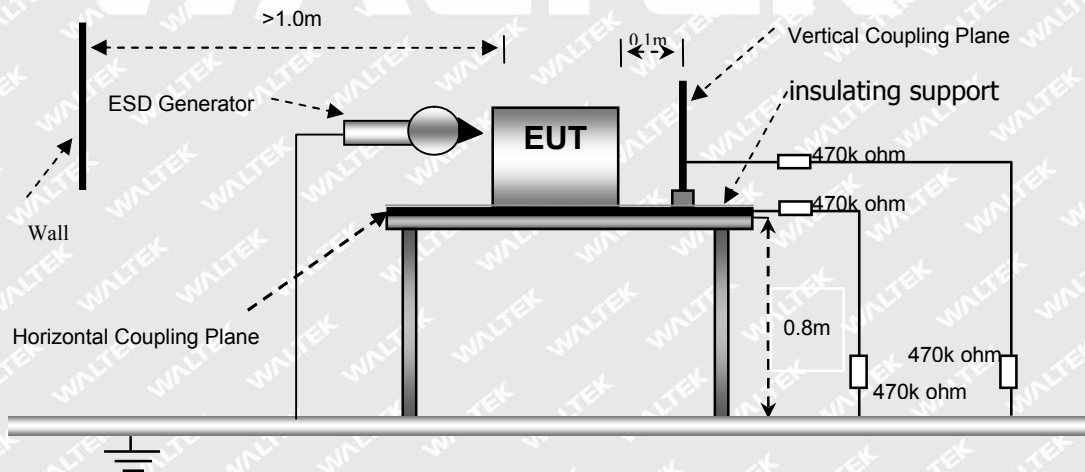



7.2.3 Test Results

Indirect Application			Performance Criteria	
Discharge Level (kV)	Polarity (+/-)	Test Point	Horizontal Coupling	Vertical Coupling
2,4	+/-	1	TT/TR	TT/TR
Remark: Test points : 1. All sides(Front/Top/ Back/ Left/Right Sides).				

Direct Application			Performance Criteria	
Discharge Level (kV)	Polarity (+/-)	Test Point	Contact Discharge	Air Discharge
2,4,8	+/-	1	N/A	TT/TR
2,4	+/-	2	TT/TR	N/A
Remark: Test points : 1. All Exposed Surface & Seams; 2. All metallic part N/A: Not applicable.				

WALTEK



7.3 Radiated Immunity(R/S)

Test Method	: EN 301 489-1, EN 61000-4-3
Face Under Test	: Three Mutually Orthogonal Faces
Severity	: 3V/m, 1kHz, 80% Amp. Mod. ; 3V/m, 200Hz, 100% Amp. Mod. ; CW;
Test Result	: PASS

7.3.1 E.U.T. Operation

Operating Environment:

Temperature	: 21.4°C
Humidity	: 52.6 % RH
Barometric Pressure	: 101.2kPa

EUT Operation :

Refer to section 6.5.

7.3.2 Block Diagram of Setup

The Radiated Immunity test was performed in accordance with the EN 61000-4-3.

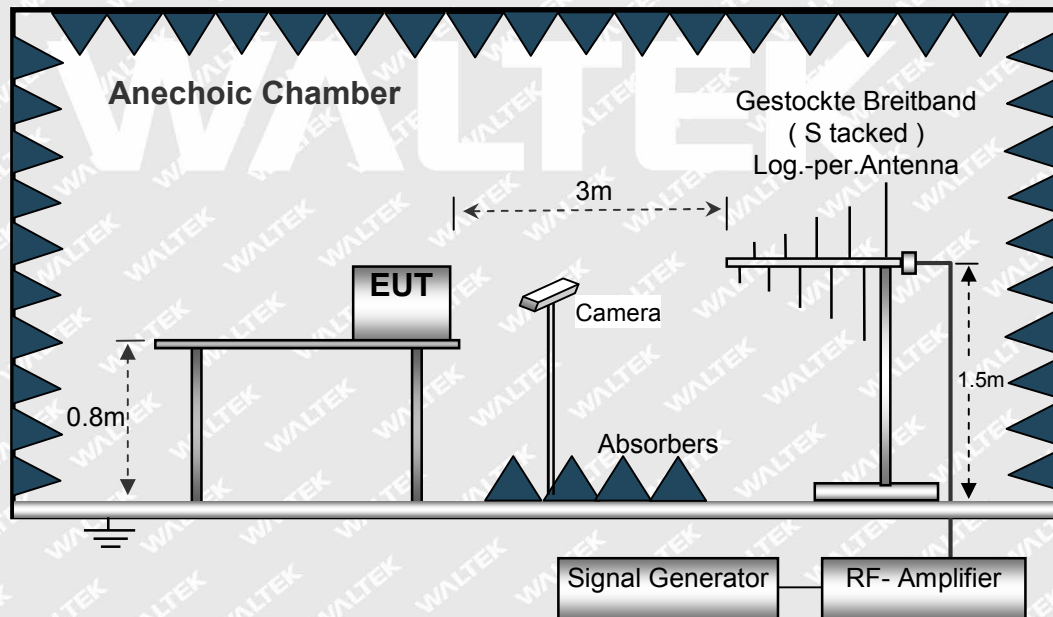



7.3.3 Test Results

EN 301 489-17

Frequency	Level	Modulation	EUT Face	Performance Criteria	BER
80MHz -3GHz,	3V/m	1kHz, 80%, Amp. Mod.	Front, Back Left, Right	CT/CR	0.000%
3GHz - 6GHz	3V/m	1kHz, 80%, Amp. Mod.	Front, Back Left, Right	CT/CR	0.000%

WALTEK



8 Photographs – Test Setup

8.1 Photograph - Radiated Emissions Test Setup

For 30MHz-1000MHz

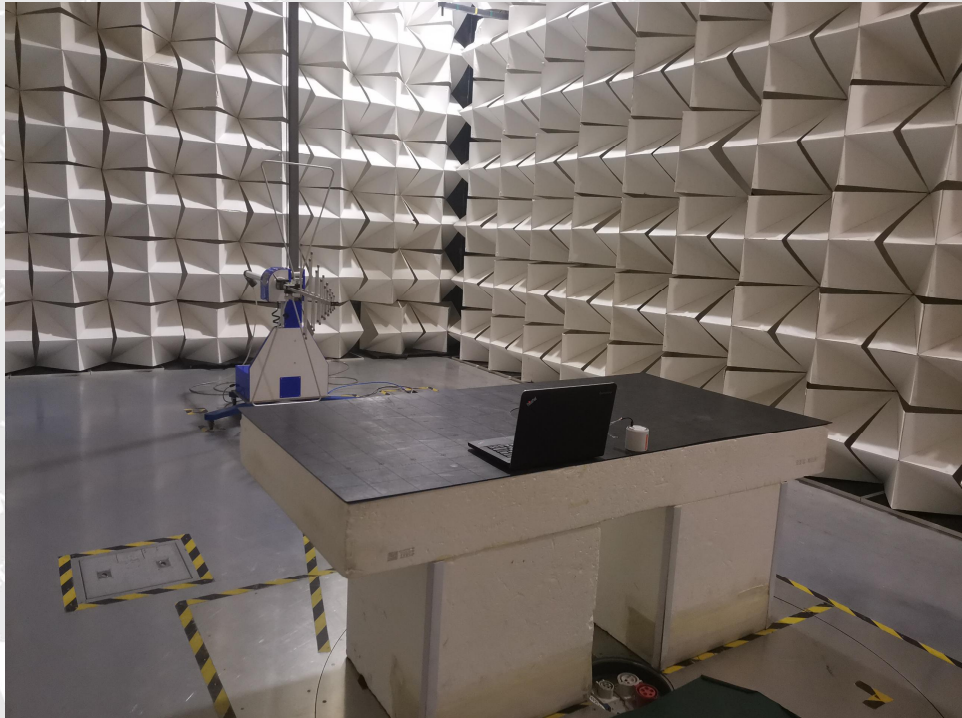

For Above 1GHz

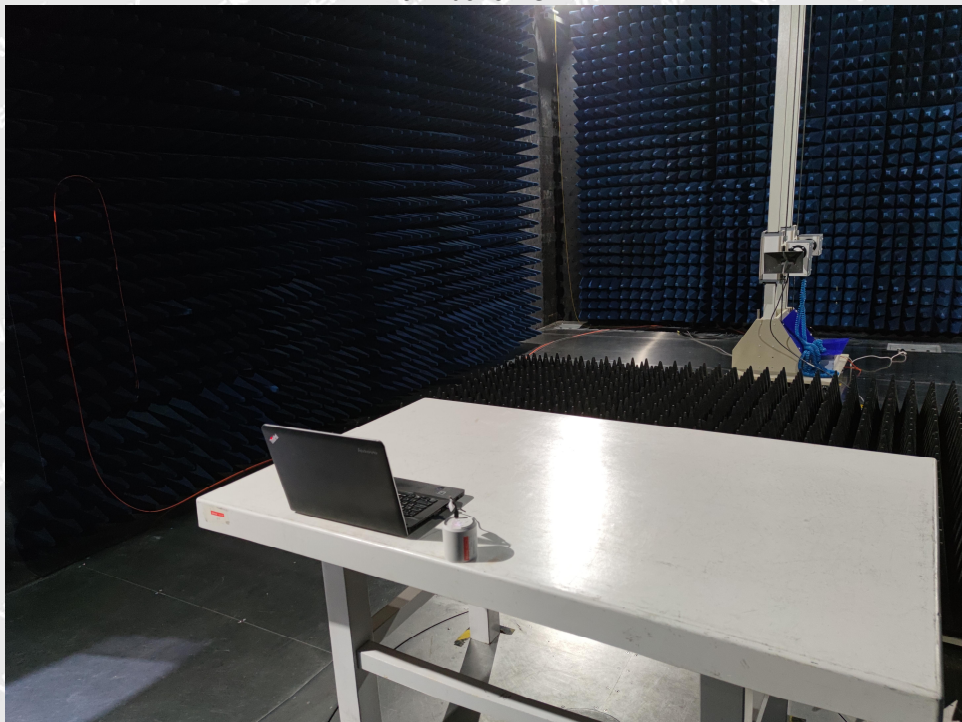



8.2 Photograph - Radiated immunity Test Setup

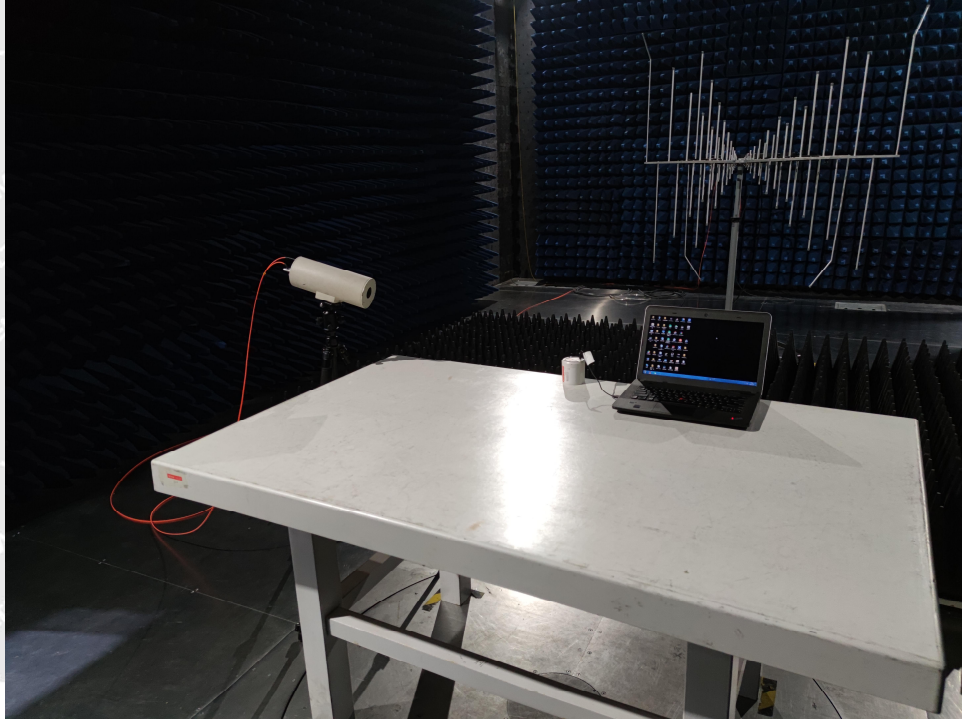

8.3 Photograph - ESD Test Setup





9 Photographs of EUT

9.1 EUT – Appearance View Model: MO6251



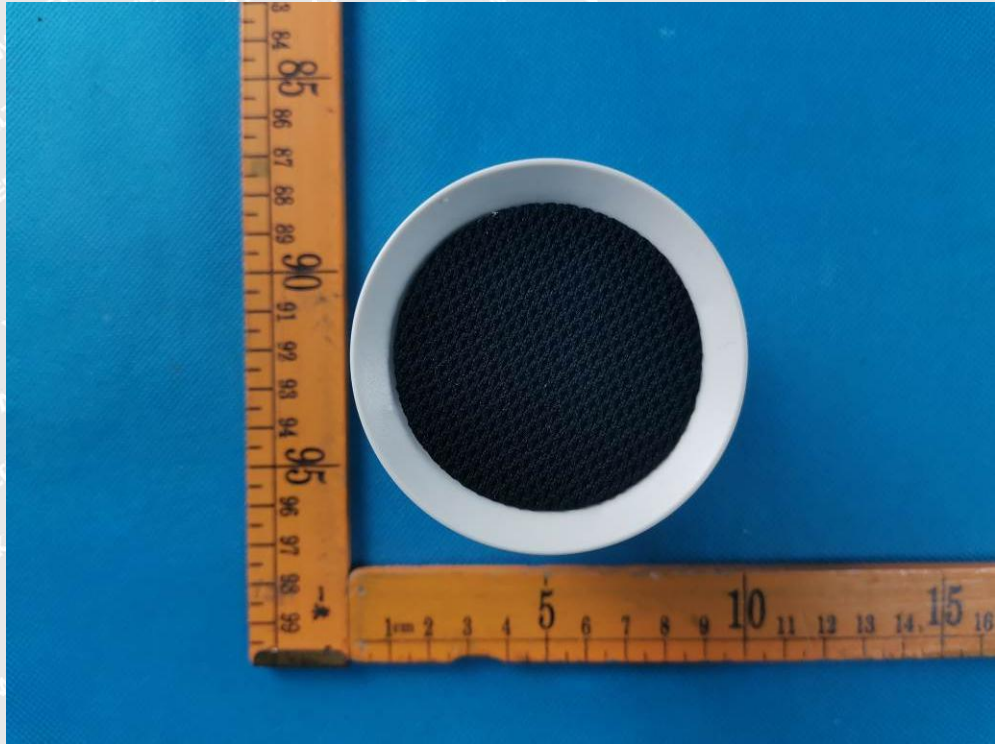





9.2 EUT – Open View Model: MO6251



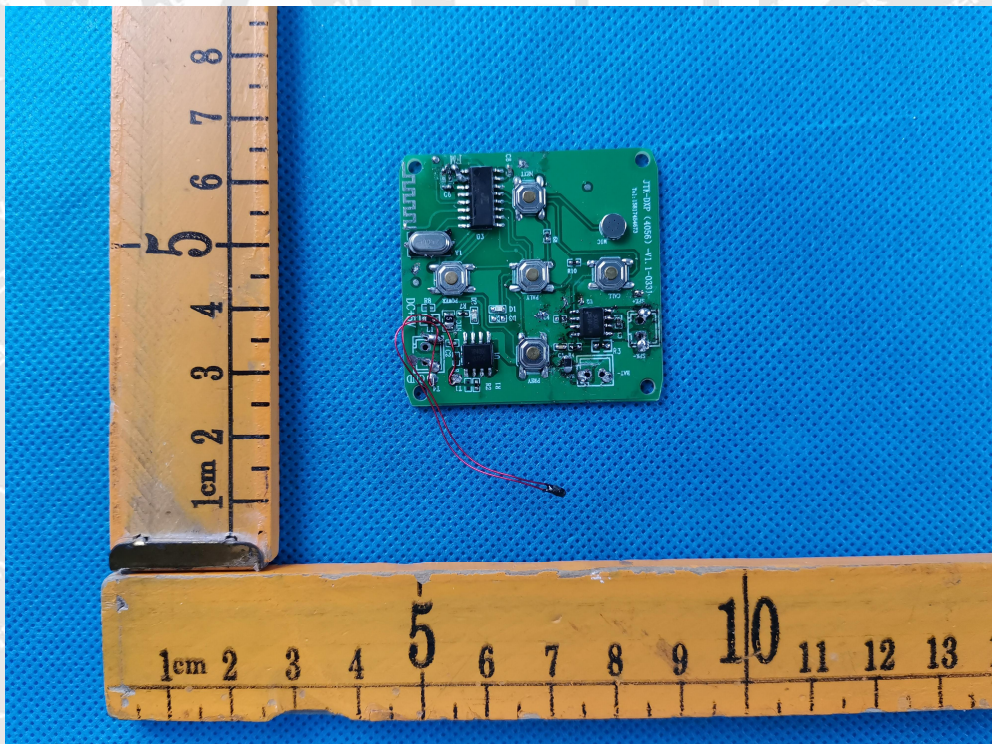

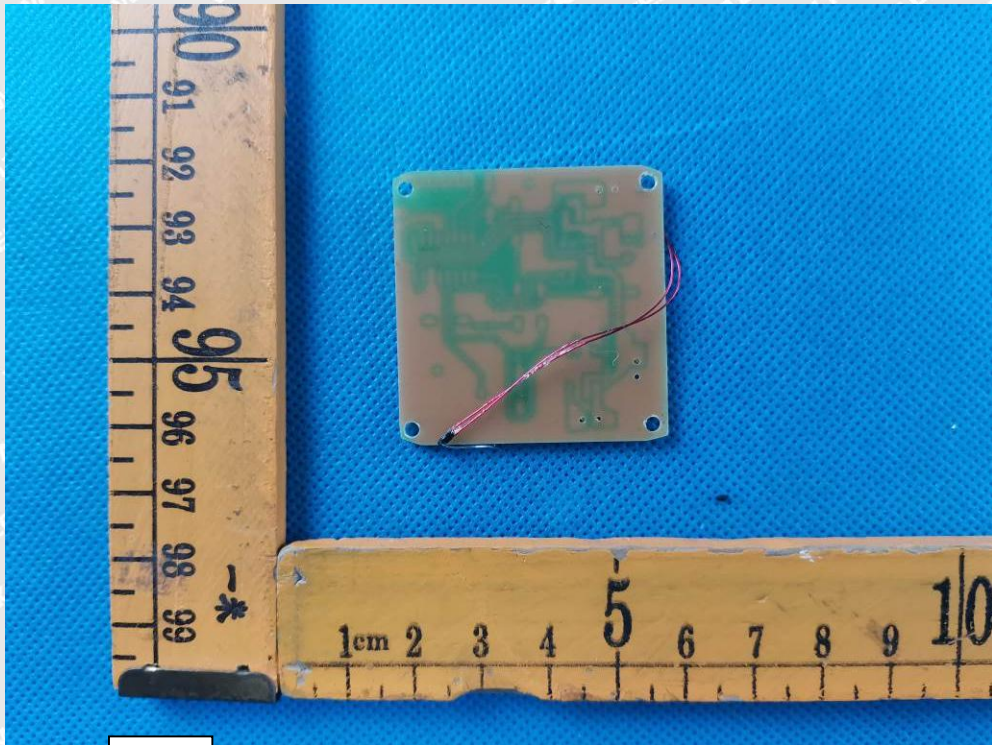

ANT

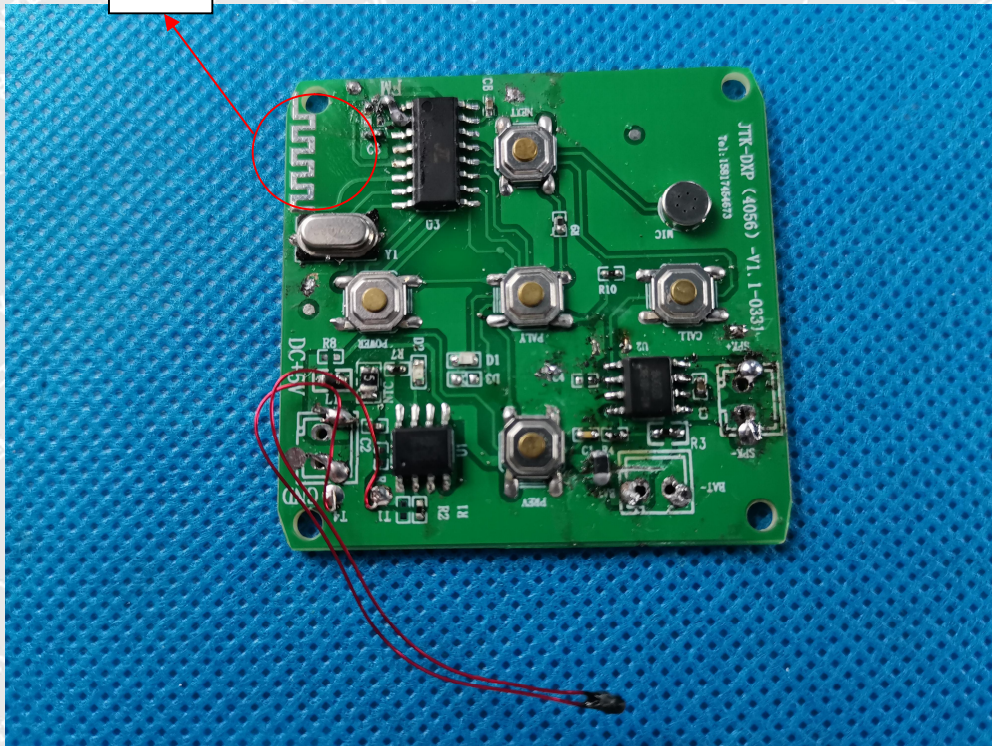

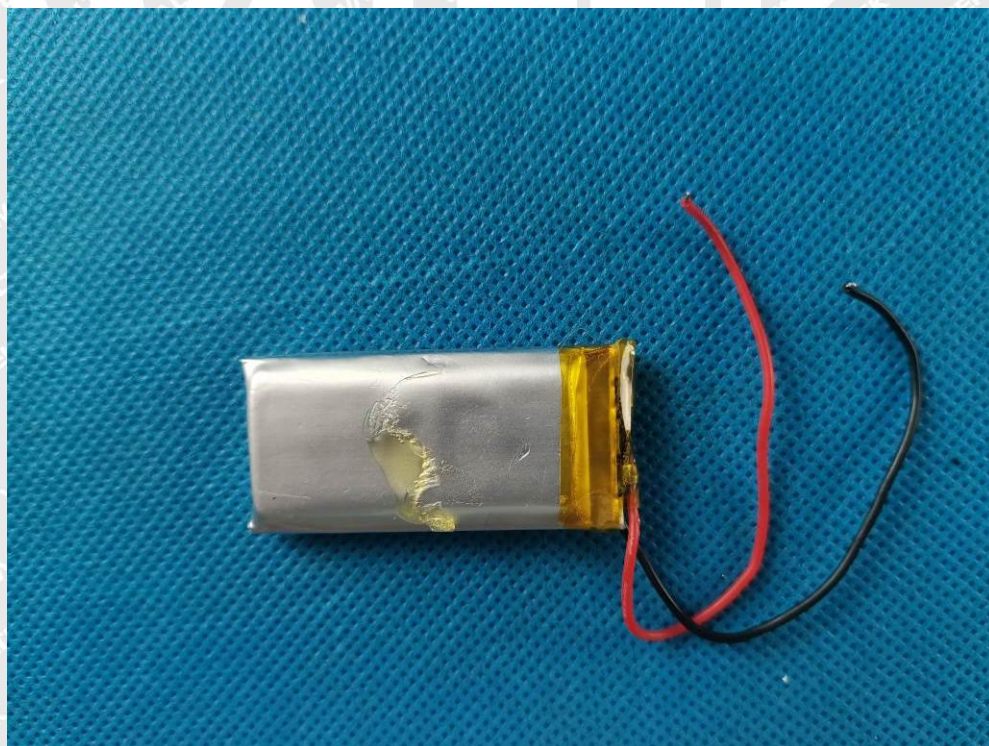

====End====



中国认可
国际互认
检测
TESTING
CNAS L3110



TEST REPORT

Reference No...... : WTF21D04041012E
Manufacturer*..... : Mid Ocean Brands B.V.
Address..... : 7/F., Kings Tower, 111 King Lam Street, Cheung Sha Wan, Kowloon, Hong Kong
Factory..... : 116266
Product..... : RABS 3W round wireless speaker
Model(s)..... : MO6251
Standards..... : EN 55032:2015
EN 55035:2017
EN IEC 61000-3-2:2019
EN 61000-3-3:2013+A1:2019
Date of Receipt sample ... : 2021-04-28
Date of Test..... : 2021-04-28 to 2021-05-26
Date of Issue..... : 2021-05-26
Test Result..... : **Pass**

Remarks:

The results shown in this test report refer only to the sample(s) tested; this test report cannot be reproduced, except in full, without prior written permission of the company. The report would be invalid without specific stamp of test institute and the signatures of compiler and approver.

Prepared By:

Waltek Testing Group Co., Ltd.

Address: No. 77, Houjie Section, Guantai Road, Houjie Town, Dongguan City, Guangdong, China

Tel: +86-769-2267 6998

Fax: +86-769-2267 6828

Compiled by:

Andy Feng / Project Engineer

Approved by:

Ford Wang / Designated Reviewer



1 Contents

	Page
COVER PAGE	1
1 CONTENTS	2
2 REVISION HISTORY	3
3 GENERAL INFORMATION	4
3.1 GENERAL DESCRIPTION OF E.U.T.....	4
3.2 DETAILS OF E.U.T.....	4
3.3 SUBCONTRACTED.....	4
3.4 ABNORMALITIES FROM STANDARD CONDITIONS.....	4
4 TEST SUMMARY	5
5 EQUIPMENT USED DURING TEST	6
5.1 EQUIPMENT LIST.....	6
5.2 DESCRIPTION OF SUPPORT UNITS.....	7
5.3 MEASUREMENT UNCERTAINTY.....	7
5.4 TEST EQUIPMENT CALIBRATION.....	7
5.5 TEST MODE.....	7
6 EMISSION TEST RESULTS	8
6.1 RADIATED EMISSIONS,30-1000MHZ.....	8
6.2 RADIATION EMISSION, ABOVE 1000MHZ.....	11
7 IMMUNITY TEST RESULTS	15
7.1 PERFORMANCE CRITERIA.....	15
7.2 ELECTROSTATIC DISCHARGE (ESD).....	16
7.3 RADIO-FREQUENCY ELECTROMAGNETIC FIELDS.....	18
8 PHOTOGRAPHS–TEST SETUP	20
8.1 PHOTOGRAPH–RADIATIONEMISSION TEST SETUP 30MHZ-1000MHZ.....	20
8.2 PHOTOGRAPH– RADIATIONEMISSION TEST SETUP ABOVE 1GHZ.....	20
8.3 PHOTOGRAPH – ESD IMMUNITY TEST SETUP.....	21
8.4 PHOTOGRAPH –RADIO-FREQUENCY ELECTROMAGNETIC FIELDS TEST SETUP.....	21
9 PHOTOGRAPHS OF EUT	22
9.1 EUT – APPEARANCE VIEW MODEL: MO6251.....	22
9.2 EUT – OPEN VIEW MODEL: MO6251.....	25



2 Revision History

Test report No.	Date of Receipt sample	Date of Test	Date of Issue	Purpose	Comment	Approved
WTF21D04041012E	2021-04-28	2021-04-28 to 2021-05-26	2021-05-26	Original	-	Valid

WALTEK



3 General Information

3.1 General Description of E.U.T.

Product : RABS 3W round wireless speaker
Model(s)..... : MO6251
Model Difference : N/A
Remark..... : N/A

3.2 Details of E.U.T.

Ratings : Input: DC 5V(Supplied by Micro USB port)
Battery 3.7V 300mAh

3.3 Subcontracted

Whether parts of tests for the product have been subcontracted to other labs:

Yes No

If Yes, list the related test items and lab information:

Test Lab:N/A

Lab address:N/A

Test items: N/A

3.4 Abnormalities from Standard Conditions

None.



4 Test Summary

EMISSION(EN 55032)		
Test Item	Test Standard	Result
Conducted Emissions from the AC mains power ports 150KHz to 30MHz	EN 55032	N/A
Asymmetric Mode Conducted Emissions 150KHz to 30MHz	EN 55032	N/A
Conducted Differential Voltage Emissions 30MHz to 2150MHz	EN 55032	N/A
Radiated Emissions, 30MHz to 1000MHz	EN 55032	Pass
Radiated Emissions, Above 1GHz	EN 55032	Pass
Harmonic Current	EN IEC 61000-3-2	N/A
Voltage Fluctuation and Flicker	EN 61000-3-3	N/A
IMMUNITY(EN 55035)		
Test Item	Test Method	Result
Electrostatic Discharge(ESD)	IEC 61000-4-2	Pass
Radiation Immunity	IEC 61000-4-3	Pass
Electrical Fast Transients (EFT)	IEC 61000-4-4	N/A
Surges	IEC 61000-4-5	N/A
Injected Currents	IEC 61000-4-6	N/A
Power-frequency magnetic fields	IEC 61000-4-8	N/A*
Voltage Dips and Voltage interruptions	IEC 61000-4-11	N/A

Remark:

Pass

Test item meets the requirement

Fail

Test item does not meet the requirement

N/A

Test case does not apply to the test object

*

Applicable only to equipment containing devices intrinsically susceptible to magnetic fields, such as CRT monitors, Hall effect elements, electro-dynamic microphones, magnetic field sensors or audio frequency transformers.



5 Equipment Used during Test

5.1 Equipment List

3m Semi-anechoic Chamber for Radiation (Below 1GHz) TDK						
Item	Equipment	Manufacturer	Model No.	Serial No.	Last Calibration Date	Calibration Due Date
1	Test Receiver	R&S	ESCI	101296	2021-04-19	2022-04-18
2	Trilog Broadband Antenna	SCHWARZBECK	VULB9160	9160-3325	2021-04-24	2022-04-23
3	Amplifier	ANRITSU	MH648A	M43381	2021-04-19	2022-04-18
4	Cable	HUBER+SUHNER	CBL2	525178	2021-04-19	2022-04-18
5	Active Loop Antenna	Com-Power Corp.	AL-130R	10160007	2021-05-05	2022-05-04
3m Fully Anechoic Room for Radiation (Above 1GHz)						
Item	Equipment	Manufacturer	Model No.	Serial No.	Last Calibration Date	Calibration Due Date
1	Spectrum Analyzer	R&S	FSP	100091	2021-04-19	2022-04-18
2	Broad-band Horn Antenna	SCHWARZBECK	BBHA 9120 D	667	2021-04-24	2022-04-23
3	Broadband Preamplifier	COMPLIANCE DIRECTION	PAP-1G18	2004	2021-04-19	2022-04-18
4	Coaxial Cable (above 1GHz)	Top	1GHz-18GHz	NA	2021-04-19	2022-04-18
Electrostatic Discharge						
Item	Equipment	Manufacturer	Model No.	Serial No.	Last Calibration Date	Calibration Due Date
1	Electrostatic Discharge Simulator	SCHLODER	SESD 216	606144	2021-04-23	2022-04-22
Radio-frequency electromagnetic fields						
Item	Equipment	Manufacturer	Model No.	Serial No.	Last Calibration Date	Calibration Due Date
1	Signal Generater	R&S	SMB100A	105942	2020-07-30	2021-07-29
2	RF Power Amplifier	BONN Elektronik	BLWA0830-160/100/40D	128740	2020-07-30	2021-07-29
3	GestockteBreitband (S tacked) Log.-per.Antenna	SCHWARZBECK	STLP9128D	043	2020-07-30	2021-07-29
4	Power Meter	R&S	NRP2	102031	2021-04-19	2022-04-18
5	Amplifier	NJNT	NTWPAS-2560025	2560025	2021-04-19	2022-04-18



5.2 Description of Support Units

Equipment	Manufacturer	Model No.	Series No.
/	/	/	/

5.3 Measurement Uncertainty

Parameter	Uncertainty (Note 1)
Temperature	$\pm 1^{\circ}\text{C}$
Humidity	$\pm 5\%$
DC and low frequency voltages	$\pm 3\%$
Conducted Emission (150kHz-30MHz)	$\pm 3.64\text{dB}$
Radiated Emission(30MHz-1000MHz)	$\pm 5.03\text{dB}$
Radiated Emission(1GHz~18GHz)	$\pm 5.47\text{dB}$

Note 1: This uncertainty represents an expanded uncertainty expressed at approximately the 95% confidence level using a coverage factor of $k=2$.

5.4 Test Equipment Calibration

All the test equipments used are valid and calibrated by GUANG ZHOU GRG METROLOGY & TEST CO., LTD. address is No.163, Pingyun Rd. West of Huangpu Ave, Tianhe District, Guangzhou, Guangdong, China.

5.5 Test Mode

Radiated Emissions	
TM1*	Charging +BT mode
Electrostatic Discharge(ESD)	
TM1*	Charging +BT mode
Radiated Immunity(R/S)	
TM1*	Charging +BT mode



6 Emission Test Results

6.1 Radiated Emissions,30-1000MHz

Test Requirement..... : EN 55032
 Test Method..... : EN 55032
 Frequency Range..... : 30MHz to 1000MHz
 Class/Severity..... : Class B/ Table A.4 of EN 55032
 Test Result : Pass Fail not applicable (Remark)

6.1.1E.U.T. Operation

Operating Environment:

Temperature..... : 23.1°C
 Humidity..... : 54.8%RH
 Atmospheric Pressure..... : 101.5kPa
 EUT Operation..... : Refer to section 5.5.

6.1.2Block Diagram of Test Setup

The Radiation Emission tests were performed in the 3m Semi- Anechoic Chamber test site, using the setup accordance with the EN 55032.

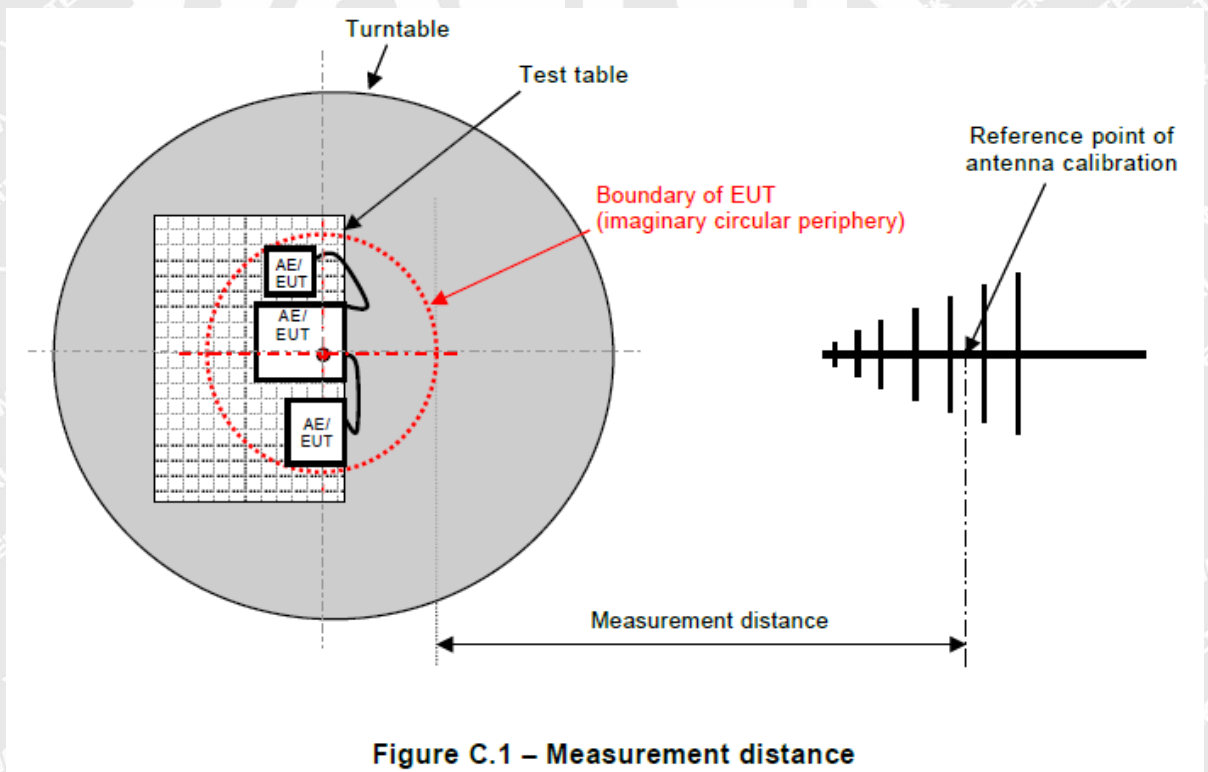

Figure C.1 – Measurement distance



6.1.3 Measurement Data

The maximised peak emissions from the EUT was scanned and measured for both the Antenna Vertical Polarization and Antenna Horizontal Polarization. Quasi-peak measurements were performed if peak emissions were within 6dB of the Quasi-peak limit line.

6.1.4 Corrected Amplitude & Margin Calculation

The Corrected Amplitude is calculated by adding the Antenna Factor and Cable Factor, and subtracting the Amplifier Gain from the Amplitude reading. The basic equation is as follows:

$$\text{Corr. Ampl.} = \text{Indicated Reading} + \text{Antenna Factor} + \text{Cable Factor} - \text{Amplifier Gain}$$

The “Margin” column of the following data tables indicates the degree of compliance with the applicable limit. For example, a margin of -6dB means the emission is 6dB below the maximum limit. The equation for margin calculation is as follows:

$$\text{Margin} = \text{Corr. Ampl.} - \text{Limit}$$

6.1.5 Test Data

Antenna Polarization: Vertical

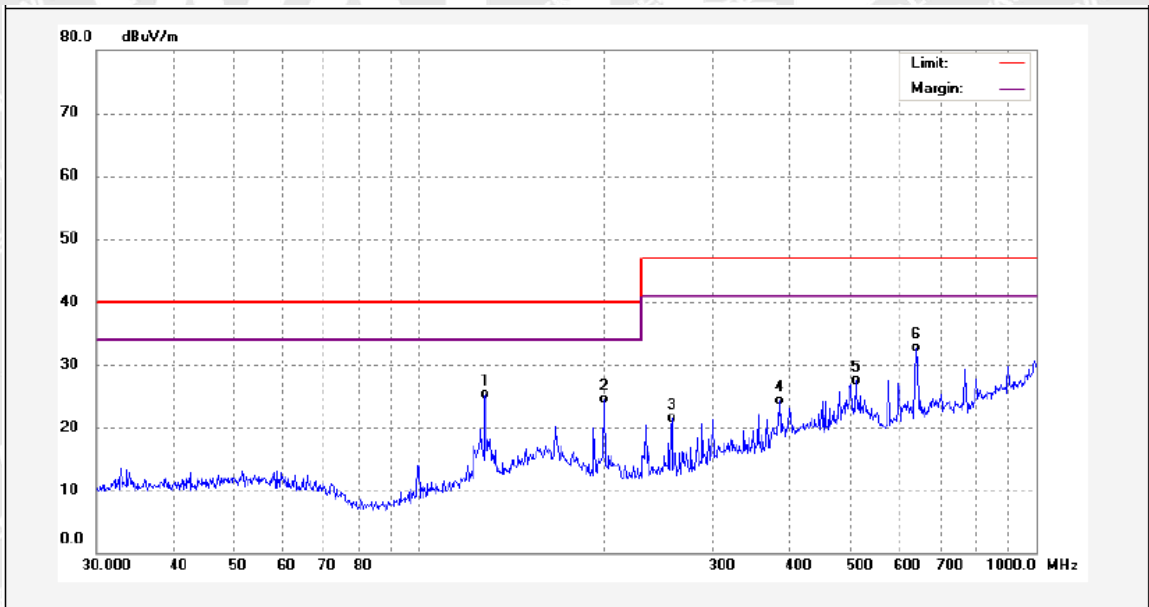

No.	Freq. (MHz)	Reading (dBuV/m)	Factor (dB)	Result (dBuV/m)	Limit (dBuV/m)	Margin (dB)	Detector	Remark
1	128.1127	41.87	-16.62	25.25	40.00	-14.75	QP	
2	199.9855	42.81	-18.26	24.55	40.00	-15.45	QP	
3	256.5210	37.85	-16.40	21.45	47.00	-25.55	QP	
4	383.9318	37.25	-12.85	24.40	47.00	-22.60	QP	
5	510.0434	36.91	-9.42	27.49	47.00	-19.51	QP	
6	638.3686	39.74	-6.96	32.78	47.00	-14.22	QP	



Antenna Polarization: Horizontal

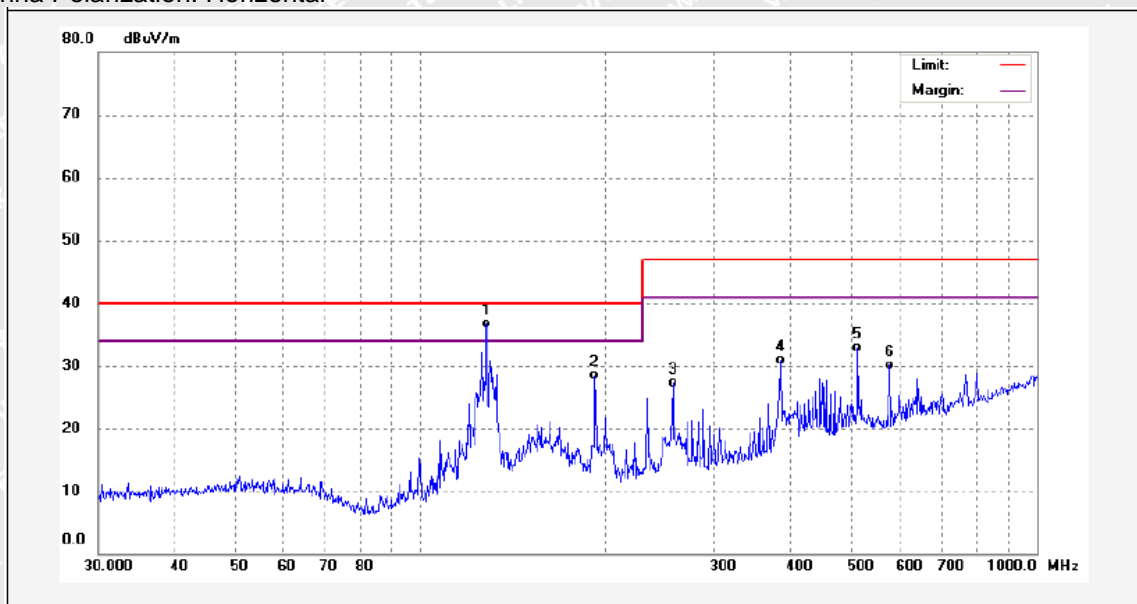

No.	Freq. (MHz)	Reading (dBuV/m)	Factor (dB)	Result (dBuV/m)	Limit (dBuV/m)	Margin (dB)	Detector	Remark
1	128.1126	53.32	-16.62	36.70	40.00	-3.30	QP	
2	191.7450	46.44	-17.97	28.47	40.00	-11.53	QP	
3	256.5210	43.61	-16.40	27.21	47.00	-19.79	QP	
4	383.9318	43.72	-12.85	30.87	47.00	-16.13	QP	
5	511.8351	42.15	-9.29	32.86	47.00	-14.14	QP	
6	576.6443	38.82	-8.66	30.16	47.00	-16.84	QP	



6.2 Radiation Emission, Above 1000MHz

Test Requirement..... : EN 55032
 Test Method..... : EN 55032
 Frequency Range..... : Above 1000MHz
 Class/Severity..... : Class B/ Table A.5 of EN 55032
 Test Result : Pass Fail not applicable (Remark)

6.2.1E.U.T. Operation

Operating Environment:

Temperature..... : 23.5°C
 Humidity..... : 52.3%RH
 Atmospheric Pressure..... : 101.3kPa
 EUT Operation..... : Refer to section 5.5.

6.2.2Block Diagram of Test Setup

The Radiation emission tests were performed in the 3m Semi- Anechoic Chamber test site, using the setup accordance with the EN 55032.

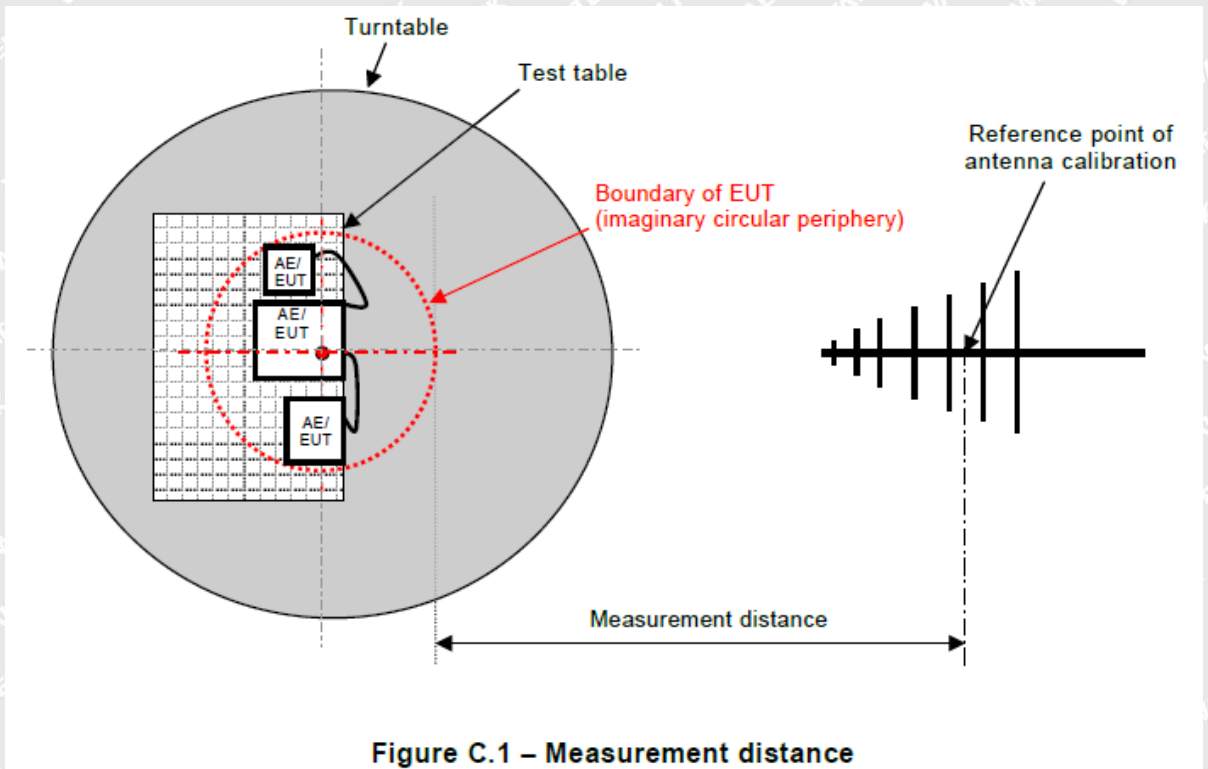

Figure C.1 – Measurement distance



6.2.3 Measurement Data

The maximised peak emissions from the EUT was scanned and measured for both the Antenna Vertical Polarization and Antenna Horizontal Polarization. Average measurements were performed if peak emissions were within 6dB of the average limit line.

The test Frequency range judgment basis:

If the highest frequency of the internal sources of the EUT is less than 108 MHz, the measurement shall only be made up to 1 GHz.

If the highest frequency of the internal sources of the EUT is between 108 MHz and 500 MHz, the measurement shall only be made up to 2 GHz.

If the highest frequency of the internal sources of the EUT is between 500 MHz and 1 GHz, the measurement shall only be made up to 5 GHz.

If the highest frequency of the internal sources of the EUT is above 1 GHz, the measurement shall be made up to 5 times the highest frequency or 6 GHz, whichever is less.

6.2.4 Corrected Amplitude & Margin Calculation

The Corrected Amplitude is calculated by adding the Antenna Factor and Cable Factor, and subtracting the Amplifier Gain from the Amplitude reading. The basic equation is as follows:

$$\text{Corr. Ampl.} = \text{Indicated Reading} + \text{Antenna Factor} + \text{Cable Factor} - \text{Amplifier Gain}$$

The “**Margin**” column of the following data tables indicates the degree of compliance with the applicable limit. For example, a margin of -6dB means the emission is 6dB below the maximum limit. The equation for margin calculation is as follows:

$$\text{Margin} = \text{Corr. Ampl.} - \text{Limit}$$



6.2.5 Test Data

Antenna Polarization: Vertical

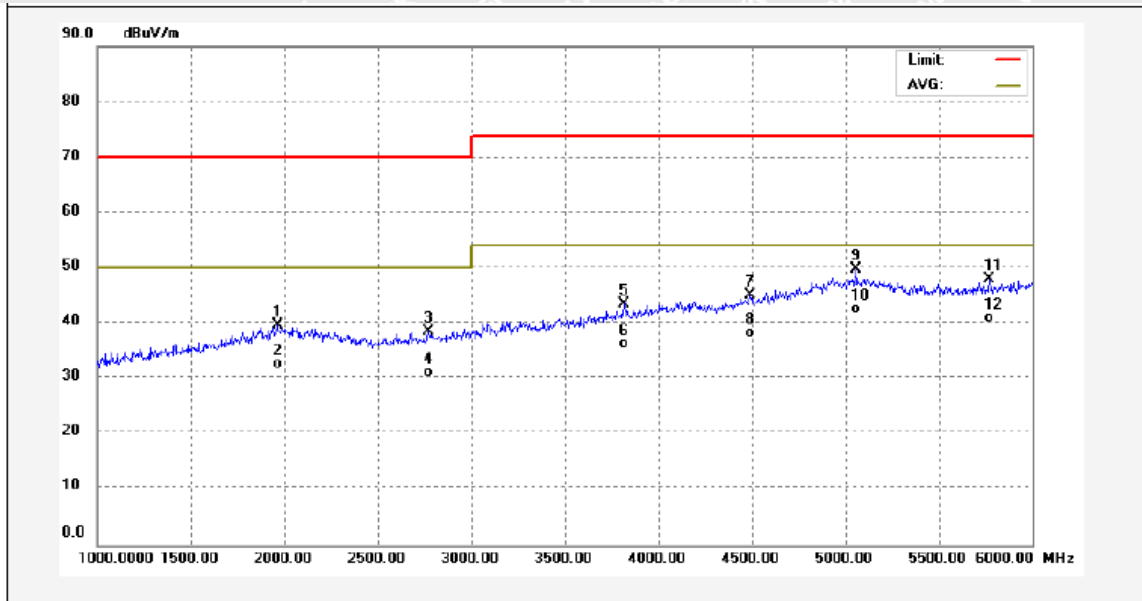

No.	Freq. (MHz)	Reading (dBuV/m)	Factor (dB)	Result (dBuV/m)	Limit dBuV/	Margin (dB)	Detector	Remark
1	1960.000	50.44	-10.64	39.80	70.00	-30.20	peak	
2	1960.000	43.29	-10.64	32.65	50.00	-17.35	AVG	
3	2770.000	49.86	-11.36	38.50	70.00	-31.50	peak	
4	2770.000	42.62	-11.36	31.26	50.00	-18.74	AVG	
5	3815.000	51.36	-7.71	43.65	74.00	-30.35	peak	
6	3815.000	44.07	-7.71	36.36	54.00	-17.64	AVG	
7	4490.000	50.53	-5.31	45.22	74.00	-28.78	peak	
8	4490.000	43.74	-5.31	38.43	54.00	-15.57	AVG	
9	5055.000	51.28	-1.54	49.74	74.00	-24.26	peak	
10	5055.000	44.22	-1.54	42.68	54.00	-11.32	AVG	
11	5770.000	50.57	-2.51	48.06	74.00	-25.94	peak	
12	5770.000	43.52	-2.51	41.01	54.00	-12.99	AVG	



Antenna Polarization: Horizontal

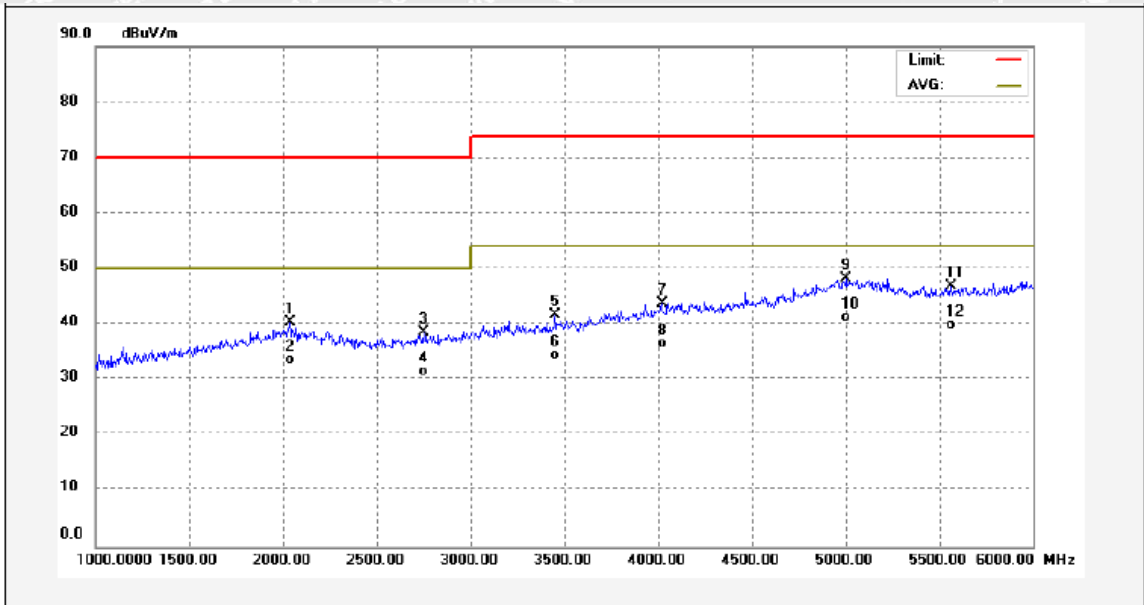

No.	Freq. (MHz)	Reading (dBuV/m)	Factor (dB)	Result (dBuV/m)	Limit dBuV/	Margin (dB)	Detector	Remark
1	2035.000	48.81	-8.53	40.28	70.00	-29.72	peak	
2	2035.000	42.16	-8.53	33.63	50.00	-16.37	AVG	
3	2750.000	46.28	-7.63	38.65	70.00	-31.35	peak	
4	2750.000	39.19	-7.63	31.56	50.00	-18.44	AVG	
5	3450.000	48.75	-7.06	41.69	74.00	-32.31	peak	
6	3450.000	41.62	-7.06	34.56	54.00	-19.44	AVG	
7	4020.000	50.21	-6.47	43.74	74.00	-30.26	peak	
8	4020.000	43.00	-6.47	36.53	54.00	-17.47	AVG	
9	5000.000	52.25	-4.05	48.20	74.00	-25.80	peak	
10	5000.000	45.41	-4.05	41.36	54.00	-12.64	AVG	
11	5560.000	49.78	-2.90	46.88	74.00	-27.12	peak	
12	5560.000	42.88	-2.90	39.98	54.00	-14.02	AVG	



7 Immunity Test Results

7.1 Performance Criteria

Performance criterion A: The apparatus shall continue to operate as intended during the test.

No degradation of performance or loss of function is allowed below a performance level (or permissible loss of performance) specified by the manufacturer, when the apparatus is used as intended. If the minimum performance level or the permissible performance loss is not specified by the manufacturer, then either of these may be derived from the product description and documentation, and from what the user may reasonably expect from the apparatus if used as intended.

Performance criterion B: The apparatus shall continue to operate as intended after the test.

No degradation of performance or loss of function is allowed below a performance level (or permissible loss of performance) specified by the manufacturer, when the apparatus is used as intended. During the test, degradation of performance is allowed, however, no change of actual operating state or stored data is allowed. If the minimum performance level or the permissible performance loss is not specified by the manufacturer, then either of these may be derived from the product description and documentation, and from what the user may reasonably expect from the apparatus if used as intended.

Performance criterion C: Temporary loss of function is allowed, provided the function is self-recoverable or can be restored by the operation of the controls, or by any operations specified in the instructions for use.

For further details, please refer to EN 55035.

WALTEK



7.2 Electrostatic Discharge (ESD)

Test Requirement.....	: EN 55035
Test Method.....	: IEC 61000-4-2
Test Result	: Pass
Discharge Impedance	: 330Ω / 150pF
Discharge Voltage	: Air Discharge: ±8kV Contact Discharge: ±4kV HCP & VCP: ±4kV
Polarity.....	: Positive & Negative
Number of Discharge	: Minimum 50 times at each test point(25 of each polarity)
Discharge Mode	: Single Discharge
Discharge Period.....	: 1 second minimum

7.2.1 E.U.T. Operation

Operating Environment:

Temperature.....	: 22.8°C
Humidity.....	: 54.7%RH
Barometric Pressure.....	: 100.8kPa
EUT Operation.....	: Refer to section 5.5.

7.2.2 Block Diagram of Setup

The ESD test was performed in accordance with the IEC 61000-4-2.

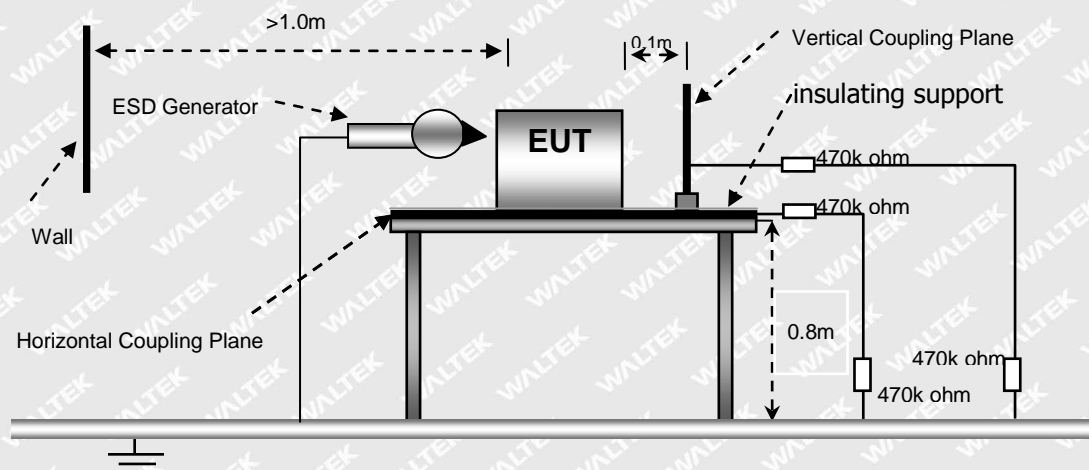



7.2.3 Direct Discharge Test Results

Observations: Test points: 1. All Exposed Surface & Seams;
2. All metallic part

Direct Discharge			Test Results	
Applied Voltage (kV)	Performance Criterion	Test Point	Contact Discharge	Air Discharge
±8	B	1	N/A	Pass
±4	B	2	Pass	N/A

7.2.4 Indirect Discharge Test Results

Observations: Test points: 1. All sides.

Indirect Discharge			Test Results	
Applied Voltage (kV)	Performance Criterion	Test Point	Horizontal Coupling	Vertical Coupling
±4	B	1	Pass	Pass

WALTEK



7.3 Radio-frequency electromagnetic fields

Test Requirement.....	: EN 55035
Test Method.....	: IEC 61000-4-3
Test Result	: Pass
FrequencyRange.....	: 80MHz to 1GHz 1.8GHz, 2.6GHz, 3.5GHz, 5GHz
Test level	: 3V/m
Modulation.....	: 80%, 1kHz Amplitude Modulation.
Face of EUT	: Front, Back, Left, Right
Antenna polarisation.....	: Horizontal&Vertical

7.3.1 E.U.T. Operation

Operating Environment:

Temperature.....	: 21.7°C
Humidity.....	: 52.4% RH
Barometric Pressure.....	: 102.4kPa
EUT Operation.....	: Refer to section 5.5.

7.3.2 Block Diagram of Setup

The Radio-frequency electromagnetic fields Immunity test was performed in accordance with the IEC 61000-4-3.

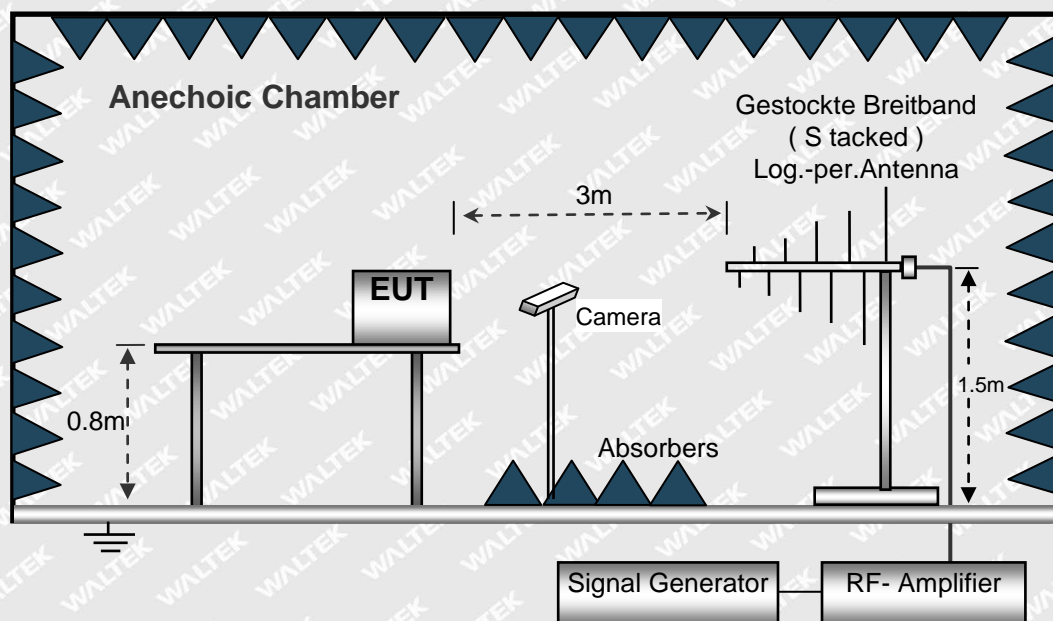



7.3.3 Test Results

Test Frequency (MHz)	Face of EUT	Antenna polarisation	Test Level	Step Size	Dwell Time	Performance Criterion	Result
80-1000MHz 1800MHz, 2600MHz, 3500MHz, 5000MHz	Front, Back, Left, Right	Horizontal	3V/m	1%	1s	A	Pass
	Front, Back, Left, Right	Vertical	3V/m	1%	1s	A	Pass

WALTEK



8 Photographs–Test Setup

8.1 Photograph–RadiationEmission Test Setup 30MHz-1000MHz

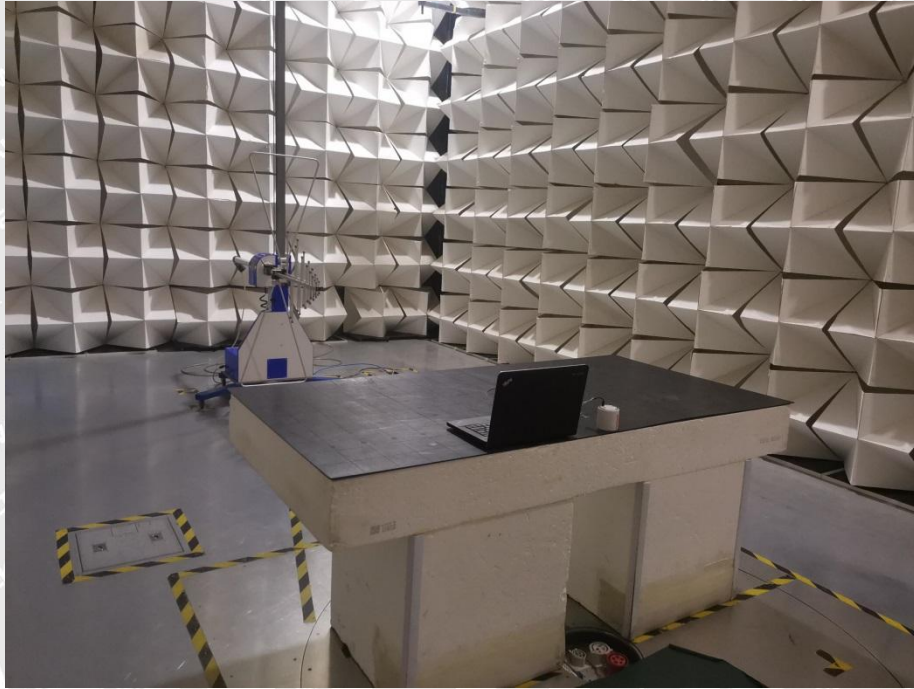

8.2 Photograph– RadiationEmission Test Setup Above 1GHz

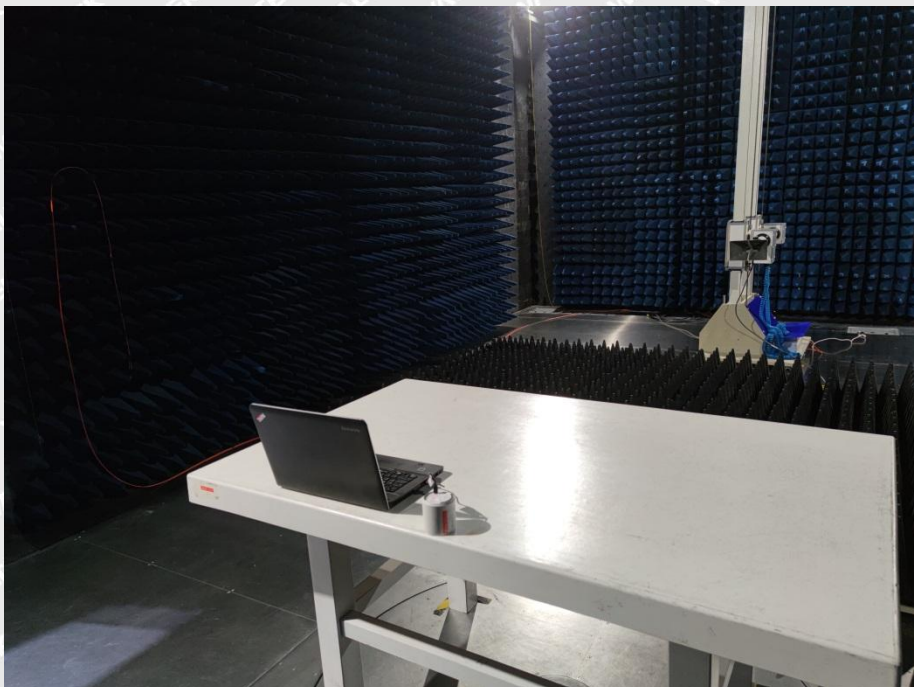



8.3 Photograph – ESD Immunity Test Setup



8.4 Photograph – Radio-frequency electromagnetic fields Test Setup

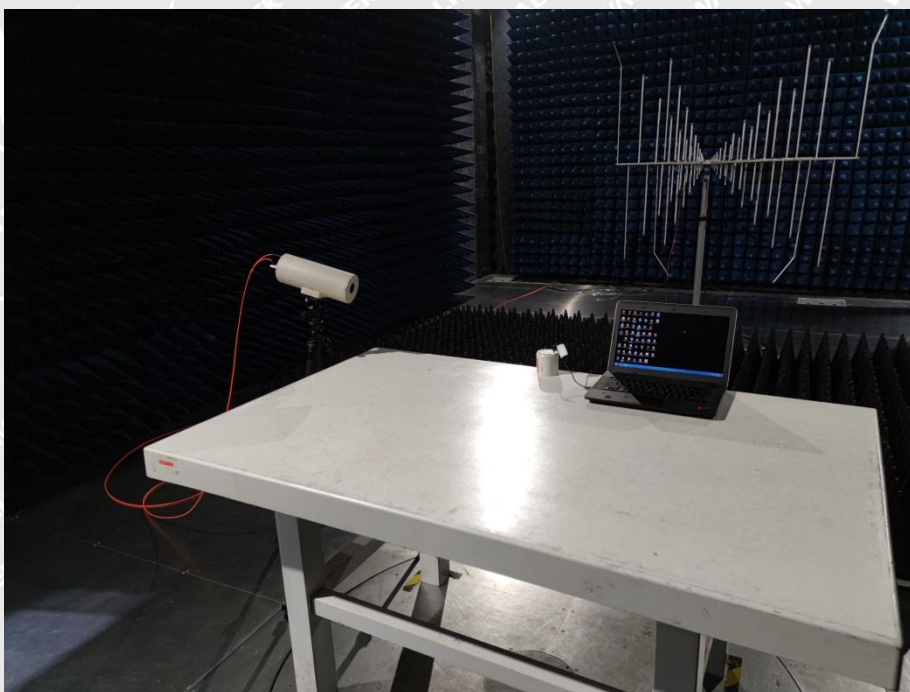



9 Photographs of EUT

9.1 EUT – Appearance View Model: MO6251









9.2 EUT – Open View Model: MO6251



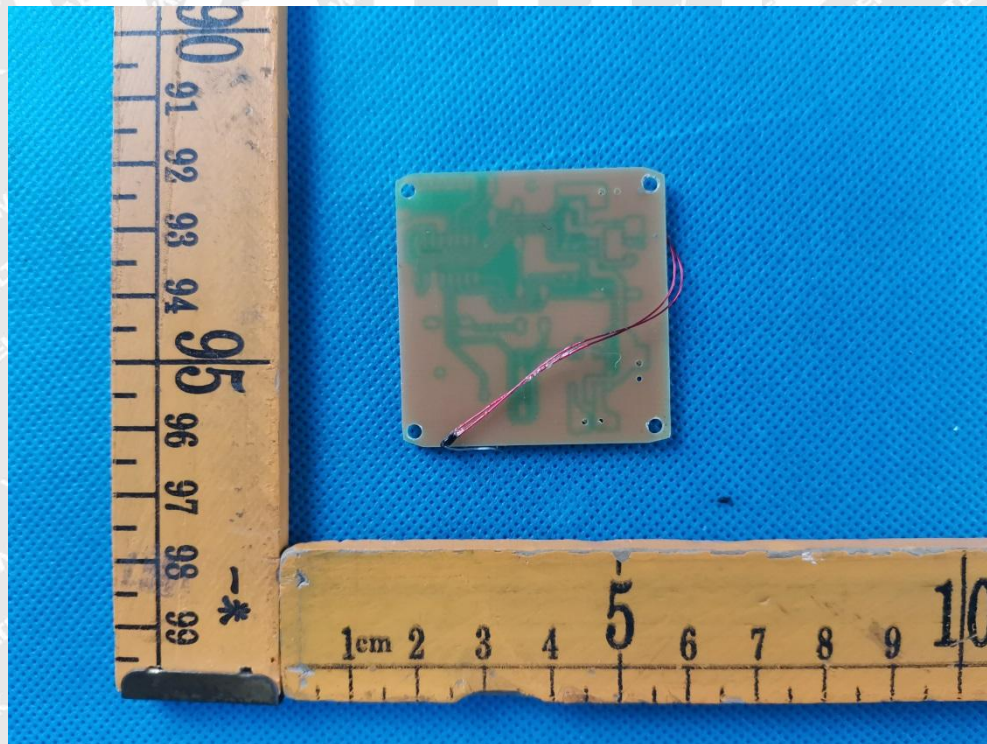
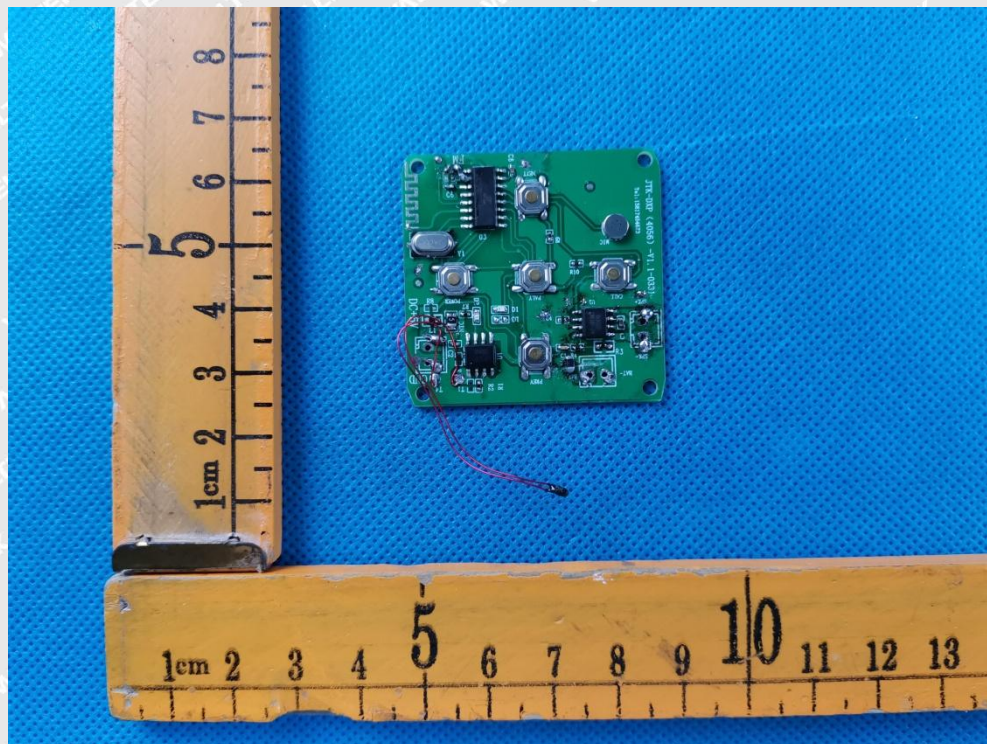

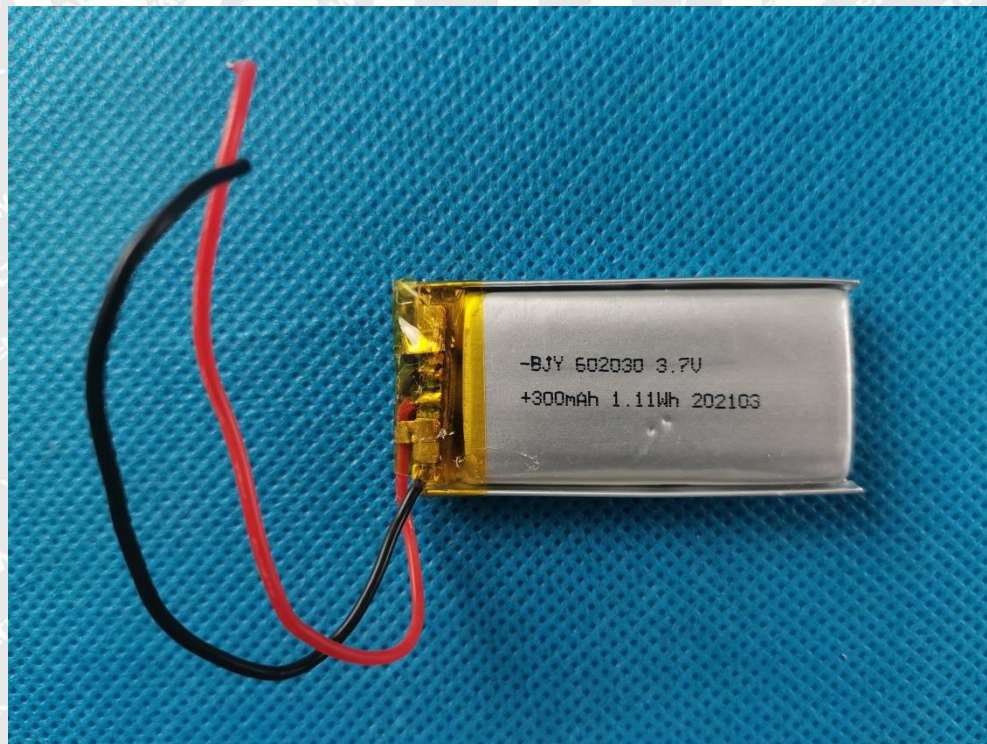
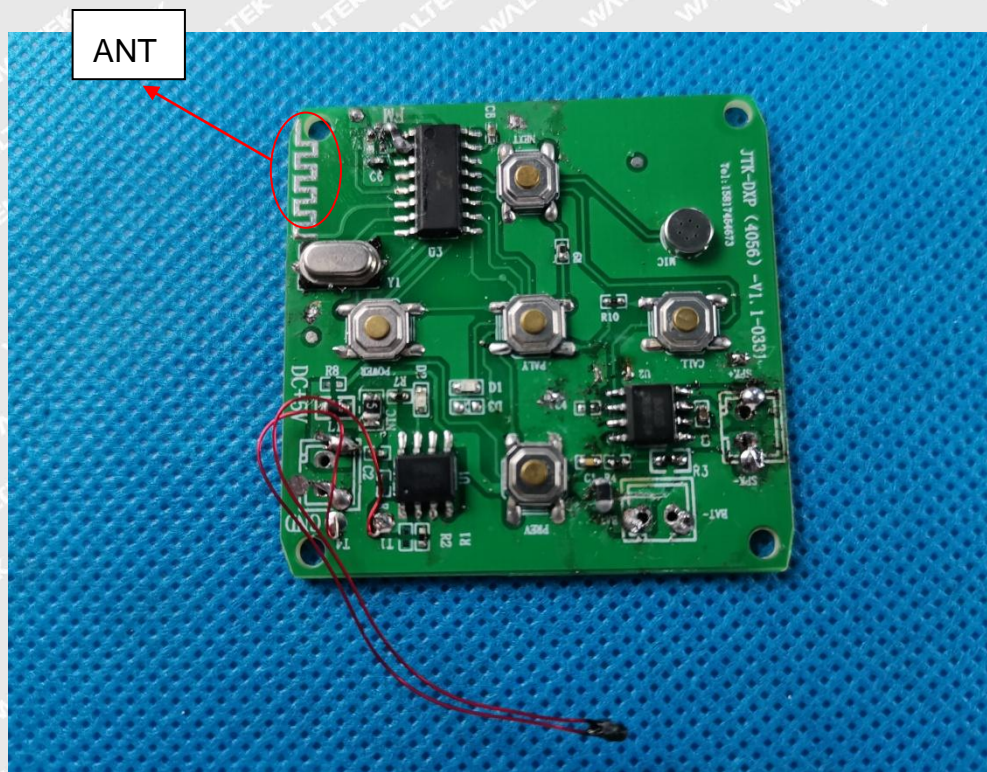



WALTEK =====End=====