



EMC TEST REPORT

For

Mid Ocean Brands B.V.

Wireless charger

Test Model: MO9310

Prepared for : Mid Ocean Brands B.V.
Address : 7/F., Kings Tower, 111 King Lam Street, Cheung Sha Wan, Kowloon, Hong Kong

Prepared by : Shenzhen LCS Compliance Testing Laboratory Ltd.
Address : Room 101, 201, Building A and Room 301, Building C, Juji Industrial Park, Yabianxueziwei, Shajing Street, Bao'an District, Shenzhen, Guangdong, China

Tel : (+86)755-82591330
Fax : (+86)755-82591332
Web : www.LCS-cert.com
Mail : webmaster@LCS-cert.com

Date of receipt of test sample : February 28, 2024
Number of tested samples : 2
Sample No. : A240219020-1, A240219020-2
Serial number : Prototype
Date of Test : February 28, 2024 ~ March 04, 2024
Date of Report : March 05, 2024





EMC TEST REPORT	
ETSI EN 301 489-1 V2.2.3 (2019-11) & ETSI EN 301 489-3 V2.3.2 (2023-01)	
Report Reference No.	LCSA02194097EA
Date Of Issue	March 05, 2024
Testing Laboratory Name	Shenzhen LCS Compliance Testing Laboratory Ltd.
Address	Room 101, 201, Building A and Room 301, Building C, Juji Industrial Park, Yabianxueziwei, Shajing Street, Bao'an District, Shenzhen, Guangdong, China
Testing Location/ Procedure ...	Full application of Harmonised standards <input checked="" type="checkbox"/> Partial application of Harmonised standards <input type="checkbox"/> Other standard testing method <input type="checkbox"/>
Applicant's Name	Mid Ocean Brands B.V.
Address	7/F., Kings Tower, 111 King Lam Street, Cheung Sha Wan, Kowloon, Hong Kong
Test Specification	
Standard	ETSI EN 301 489-1 V2.2.3 (2019-11) ETSI EN 301 489-3 V2.3.2 (2023-01) EN 55032:2015/A1:2020 EN 55035:2017/A11:2020
Test Report Form No.	LCSEMC-1.0
TRF Originator	Shenzhen LCS Compliance Testing Laboratory Ltd.
Master TRF	Dated 2017-06
Shenzhen LCS Compliance Testing Laboratory Ltd. All rights reserved.	
This publication may be reproduced in whole or in part for non-commercial purposes as long as the Shenzhen LCS Compliance Testing Laboratory Ltd. is acknowledged as copyright owner and source of the material. Shenzhen LCS Compliance Testing Laboratory Ltd. takes no responsibility for and will not assume liability for damages resulting from the reader's interpretation of the reproduced material due to its placement and context.	
Test Item Description.	Wireless charger
Trade Mark	N/A
Test Model	MO9310
Ratings	Input: DC 5V/2A Output: DC 5V/1A Wireless output: DC 5W
Result	Positive

Compiled by:

Joker.Hu

Joker Hu / Administrator

Supervised by:

Cary Luo

Cary Luo/ Technique principal

Approved by:

Gavin Liang

Gavin Liang/ Manager





EMC -- TEST REPORT

Test Report No. : LCSA02194097EA	<u>March 05, 2024</u> Date of issue
---	--

Test Model.....	: MO9310
EUT.....	: Wireless charger
Applicant.....	: Mid Ocean Brands B.V.
Address.....	: 7/F., Kings Tower, 111 King Lam Street, Cheung Sha Wan, Kowloon, Hong Kong
Telephone.....	: /
Fax.....	: /
Manufacturer.....	: 114628
Address.....	: /
Telephone.....	: /
Fax.....	: /
Factory.....	: 114628
Address.....	: /
Telephone.....	: /
Fax.....	: /

Test Result	Positive
--------------------	-----------------

The test report merely corresponds to the test sample.
 It is not permitted to copy extracts of these test result without the written permission of the test laboratory.





Revision History

Report Version	Issue Date	Revision Content	Revised By
000	March 05, 2024	Initial Issue	---





TABLE OF CONTENTS

1. GENERAL INFORMATION6

1.1. PRODUCT DESCRIPTION FOR EQUIPMENT UNDER TEST (EUT).....6

1.2. OBJECTIVE7

1.3. RELATED SUBMITTAL(S)/GRANT(S).....7

1.4. TEST METHODOLOGY.....7

1.5. DESCRIPTION OF TEST FACILITY7

1.6. SUPPORT EQUIPMENT LIST7

1.7. EXTERNAL I/O7

1.8. MEASUREMENT UNCERTAINTY.....8

1.9. DESCRIPTION OF TEST MODES.....8

2. SUMMARY OF TEST RESULTS.....9

3. TEST RESULTS10

3.1. LINE CONDUCTED EMISSION.....10

3.2. CONDUCTED EMISSION (WIRED NETWORK PORT)12

3.3. RADIATED DISTURBANCE13

3.4. HARMONIC CURRENT EMISSIONS.....16

3.5. VOLTAGE FLUCTUATION AND FLICKER.....17

3.6. RF ELECTROMAGNETIC FIELD (80 MHz - 6000 MHz).....18

3.7. ELECTROSTATIC DISCHARGE.....20

3.8. ELECTRICAL FAST TRANSIENT IMMUNITY.....22

3.9. RF COMMON MODE23

3.10. SURGES, LINE TO LINE AND LINE TO GROUND25

3.11. VOLTAGE DIPS/INTERRUPTIONS IMMUNITY TEST.....26

4. GENERAL PERFORMANCE CRITERIA FOR IMMUNITY TEST27

4.1. PERFORMANCE CRITERIA FOR CONTINUOUS PHENOMENA APPLIED TO TRANSMITTER (CT)27

4.2. PERFORMANCE CRITERIA FOR TRANSIENT PHENOMENA APPLIED TO TRANSMITTER (TT)27

4.3. PERFORMANCE CRITERIA FOR CONTINUOUS PHENOMENA APPLIED TO RECEIVER (CR).....27

4.4. PERFORMANCE CRITERIA FOR TRANSIENT PHENOMENA APPLIED TO RECEIVER (TR)27

5. LIST OF MEASURING EQUIPMENT29

6. PHOTOGRAPHS OF TEST SETUP.....31

7. PHOTOGRAPHS OF THE EUT.....31





1. GENERAL INFORMATION

1.1. Product Description for Equipment Under Test (EUT)

EUT : Wireless charger
Test Model : MO9310
Power Supply : Input: DC 5V/2A
 Output: DC 5V/1A
 Wireless output: DC 5W
Hardware Version : LP1616
Software Version : FF16
Wireless Charging :
Operating Frequency : 110.0~205.0KHz
Modulation Type : ASK
Antenna Type : Coil Antenna





1.2. Objective

ETSI EN 301 489-1	ElectroMagnetic Compatibility (EMC) standard for radio equipment and services; Part 1: Common technical requirements; Harmonised Standard for ElectroMagnetic Compatibility
ETSI EN 301 489-3	ElectroMagnetic Compatibility (EMC) standard for radio equipment and services; Part 3: Specific conditions for Short Range Devices (SRD) operating on frequencies between 9 kHz and 246 GHz; Harmonised Standard for ElectroMagnetic Compatibility
EN 55032	Electromagnetic compatibility of multimedia equipment — Emission Requirements
EN 55035	Electromagnetic compatibility of multimedia equipment – Immunity requirements

The objective is to determine compliance with ETSI EN 301 489-1 V2.2.3 (2019-11), ETSI EN 301 489-3 V2.3.2 (2023-01), EN 55032:2015/A1:2020 and EN 55035:2017/A11:2020.

1.3. Related Submittal(s)/Grant(s)

No Related Submittals.

1.4. Test Methodology

All measurements contained in this report were conducted with ETSI EN 301 489-1 V2.2.3 (2019-11), ETSI EN 301 489-3 V2.3.2 (2023-01), EN 55032:2015/A1:2020 and EN 55035:2017/A11:2020.

1.5. Description of Test Facility

NVLAP Accreditation Code is 600167-0.
 FCC Designation Number is CN5024.
 CAB identifier is CN0071.
 CNAS Registration Number is L4595.



1.6. Support Equipment List

Manufacturer	Description	Model	Serial Number	Certificate
HONOR	Phone	V30Pro	---	CE
SHENZHEN TIANYIN ELECTRONICS CO., LTD	Power Adapter	TPA-460502 00UU	---	CE

Note: Auxiliary equipment is provided by the laboratory.

1.7. External I/O

I/O Port Description	Quantity	Cable
Micro USB Port	1	USB Cable: 0.2m, unshielded





1.8. Measurement Uncertainty

Item	MU	Remark
Uncertainty for Power point Conducted Emissions Test	2.42dB	
Uncertainty for Radiation Emission test in 3m chamber (30MHz to 1GHz)	3.54dB	Polarize: V
	4.1dB	Polarize: H
Uncertainty for Radiation Emission test in 3m chamber (1GHz to 25GHz)	2.08dB	Polarize: H
	2.56dB	Polarize: V
Uncertainty for radio frequency	0.01ppm	
Uncertainty for conducted RF Power	0.65dB	
Uncertainty for temperature	0.2°C	
Uncertainty for humidity	1%	
Uncertainty for DC and low frequency voltages	0.06%	

1.9. Description of Test Modes

There was 2 test Modes. TM1 to TM2 were shown below:

TM1 : Operate Wireless Charging Mode

TM2 : Idle Mode

***Note:

1. All test modes were tested, but we only recorded the worst case in this report.





2. SUMMARY OF TEST RESULTS

Rule	Description of Test Items	Result
§7.1	Reference to clause 8.4 of ETSI EN 301 489-1 Conducted Emission (AC mains input/output port)	Compliant
§7.1	Reference to clause 8.3 of ETSI EN 301 489-1 Conducted Emission (DC power input/output port)	N/A*
§7.1	Reference to clause 8.7 of ETSI EN 301 489-1 Conducted Emission (Wired network port)	N/A*
§7.1	Reference to clause 8.2 of ETSI EN 301 489-1 Radiated Emission (Enclosure of ancillary equipment)	Compliant
§7.1	Reference to clause 8.5 of ETSI EN 301 489-1 Harmonic current emissions (AC mains input port)	N/A*
§7.1	Reference to clause 8.6 of ETSI EN 301 489-1 Voltage fluctuations and flicker (AC mains input port)	Compliant
§7.2	Reference to clause 9.3 of ETSI EN 301 489-1 Electrostatic discharge (Enclosure port) (EN 61000-4-2)	Compliant
§7.2	Reference to clause 9.2 of ETSI EN 301 489-1 RF electromagnetic field (80MHz to 6000MHz) (Enclosure port) (EN 61000-4-3)	Compliant
§7.2	Reference to clause 9.4 of ETSI EN 301 489-1 Fast transients common mode (signal, wired network and control ports, DC and AC power ports) (EN 61000-4-4)	Compliant
§7.2	Reference to clause 9.8 of ETSI EN 301 489-1 Surges, line to line and line to ground (AC mains power input ports, wired network ports) (EN 61000-4-5)	Compliant
§7.2	Reference to clause 9.5 of ETSI EN 301 489-1 RF common mode 0.15MHz to 80MHz (signal, wired network and control ports, DC and AC power ports) (EN 61000-4-6)	Compliant
§7.2	Reference to clause 9.6 of ETSI EN 301 489-1 Transients and surges in the vehicular environment (ISO 7637-2)	N/A*
§7.2	Reference to clause 9.7 of ETSI EN 301 489-1 Voltage dips and interruptions (AC mains power input ports) (EN 61000-4-11)	Compliant



3. TEST RESULTS

3.1. Line Conducted Emission

3.1.1 Conducted Emission Limit

Relevant Standard(s): ETSI EN 301 489-1 V2.2.3 (2019-11)/ EN 55032:2015/A1:2020 Class B

Limits for Line Conducted Emission		
Frequency (MHz)	Limit (dB μ V)	
	Quasi-peak Level	Average Level
0.15 ~ 0.50	66.0 ~ 56.0 *	56.0 ~ 46.0 *
0.50 ~ 5.00	56.0	46.0
5.00 ~ 30.00	60.0	50.0

NOTE1-The lower limit shall apply at the transition frequencies.
NOTE2-The limit decreases linearly with the logarithm of the frequency in the range 0.15MHz to 0.50MHz.

3.1.2 Test Configuration

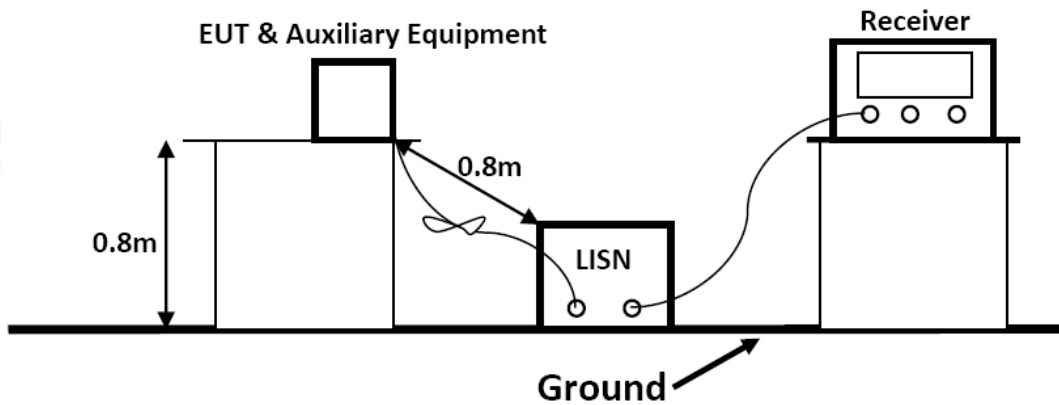

The setup of EUT is according with per ETSI EN 301 489-1 measurement procedure. The specification used was with the ETSI EN 301 489-1 limits.

The external I/O cables were draped along the test table and formed a bundle 30 to 40 cm long in the middle.

The spacing between the peripherals was 10 cm.

The EUT received charging power from the charger which received power through a LISN supplying power of AC 230V/50Hz.





3.1.3 EMI Test Receiver Setup

During the conducted emission test, the EMI test receiver was set with the following configurations:

Receiver Parameter	Setting
Attenuation	Auto
Start ~ Stop Frequency	150KHz ~ 30MHz
(IF)RBW	9kHz

All data was recorded in the Quasi-peak and average detection mode.

3.1.4 Test Procedure

Power on the EUT, the EUT begins to work. Make sure the EUT operates normally during the test.

Maximizing procedure was performed on the six (6) highest emissions of the EUT.

All data was recorded in the Quasi-peak and average detection mode.

3.1.5 Test Results

PASS

Please refer to Appendix A.1 for Emission and Immunity test results.



3.2. Conducted Emission (Wired Network Port)

3.2.1 Conducted Emission Limit(Wired Network Port)

Limits for asymmetric mode conducted emissions				
Frequency (MHz)	Class B voltage limits (dB μ V)		Class B current limits (dB μ A)	
	Quasi-peak Level	Average Level	Quasi-peak Level	Average Level
0.15 ~ 0.50	84.0~74.0	74.0~64.0	40.0~30.0	30.0~20.0
0.50 ~ 30.00	74.0	64.0	30.0	20.0

NOTE 1-The limits decrease linearly with the logarithm of the frequency in the range 0,15 MHz to 0,5 MHz.
 NOTE 2-The current and voltage disturbance limits are derived for use with an impedance stabilization network (ISN) which presents a common mode (asymmetric mode) impedance of 150 Ω to the telecommunication port under test (conversion factor is $20 \log_{10} 150 / I = 44 \text{ dB}$).

3.2.2 Test Configuration

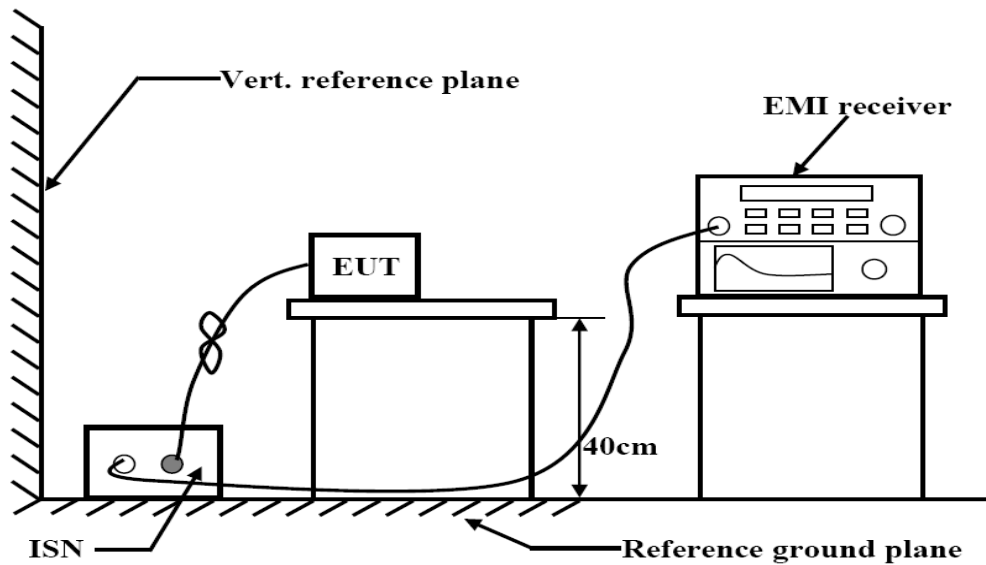

3.2.3 EMI Test Receiver Setup

During the conducted emission test, the EMI test receiver was set with the following configurations:

Receiver Parameter	Setting
Attenuation	Auto
Start ~ Stop Frequency	150KHz ~ 30MHz
(IF)RBW	9kHz

All data was recorded in the Quasi-peak and average detection mode.

3.2.4 Test Procedure

Please refer to ETSI EN 301 489-1 Clause 8.7.2 and EN 55032 Clause 6 for the measurement methods.

3.2.5 Test Results

Not applicable.





3.3. Radiated Disturbance

3.3.1 Radiated Emission Limit

Relevant Standard(s): ETSI EN 301 489-1 V2.2.3 (2019-11) / EN 55032:2015/A1:2020 Class B

Limits for Radiated Disturbance Below 1GHz			
Frequency (MHz)	Facility	Distance (Meters)	Field Strengths Limit (dB μ V/m)
30 ~ 230	FAR	3	42-35
230 ~ 1000	FAR	3	42

***Note:
 (1) The smaller limit shall apply at the combination point between two frequency bands.
 (2) Distance refers to the distance in meters between the measuring instrument antenna and the closed point of any part of the EUT.

Limits for Radiated Disturbance Above 1GHz			
Frequency (MHz)	Distance (Meters)	Peak Limit (dB μ V/m)	Average Limit (dB μ V/m)
1000 ~ 6000	3	74	54

***Note: The lower limit applies at the transition frequency.

Limits for Radiated Disturbance Below 1GHz (For FM Receivers)			
Frequency (MHz)	Distance (Meters)	Class B Limit (dB μ V/m)	
		Fundamental	Harmonics
30 ~ 230	3	60	52
230 ~ 300	3		52
300 ~ 1000	3		56

***Note: These relaxed limits apply only to emissions at the fundamental and harmonic frequencies of the LO.
 Signals at all other frequencies shall be compliant with the limits given in above Table.

Limits for Radiated Disturbance Above 1GHz (For FM Receivers)			
Frequency (MHz)	Distance (Meters)	Peak Limit (dB μ V/m)	Average Limit (dB μ V/m)
1000 ~ 6000	3	74	54

***Note: The lower limit applies at the transition frequency.



3.3.2 Test Configuration

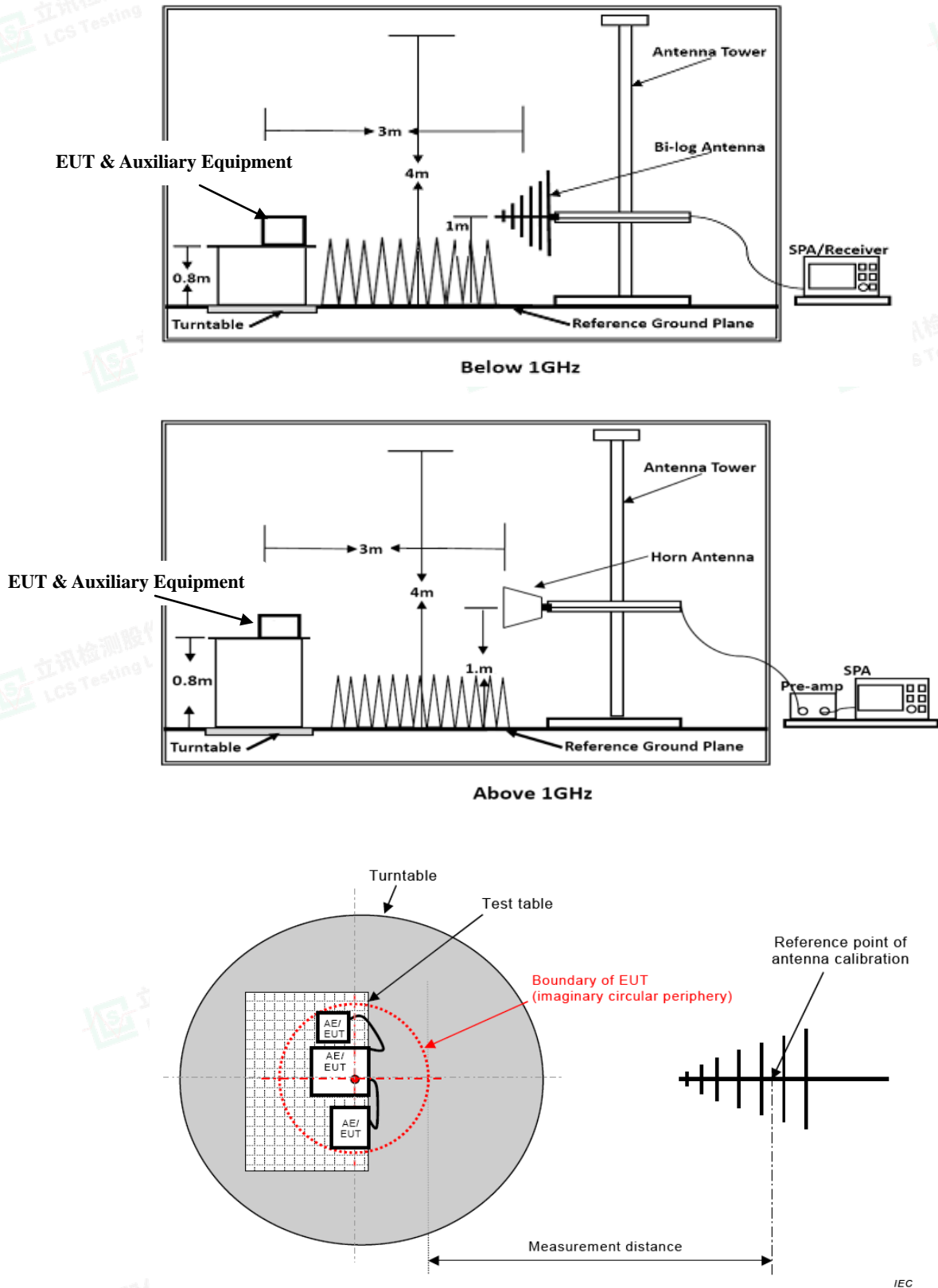

Figure C.1 – Measurement distance
Test Setup for FM Receiver



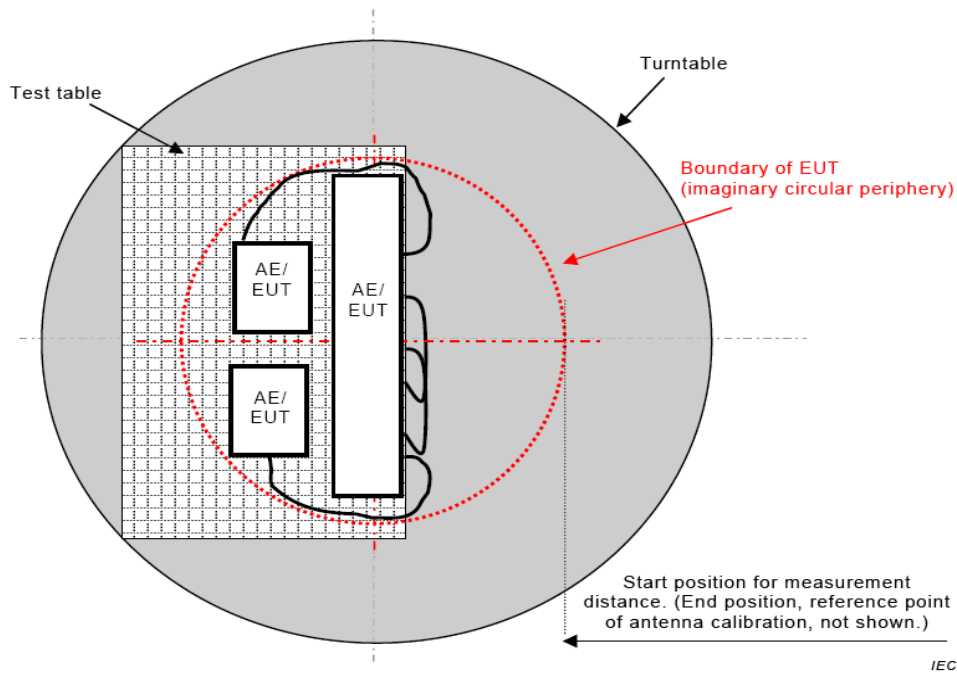

Figure C.2 – Boundary of EUT, Local AE and associated cabling

Test Setup for FM Receiver

3.3.3 Test Procedure

The test method shall be in accordance with CENELEC EN 55032 [1], annex A.3.

3.3.4 Test Results

PASS

The worst test mode of the EUT was TM1, and its test data please refer to Appendix A.3 for Emission and Immunity test results.





3.4. Harmonic Current Emissions

3.4.1 Test Configuration

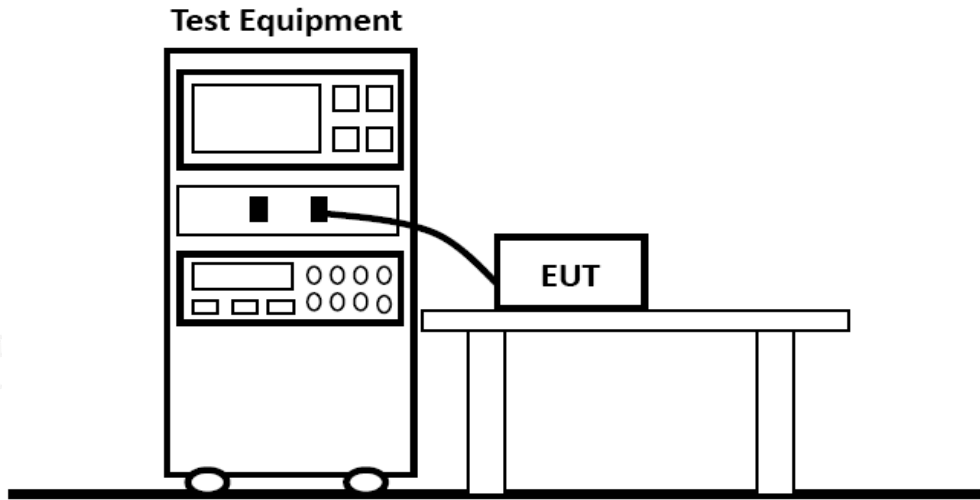

3.4.2 Test Standard

According to ETSI EN 301 489-1 V2.2.3 (2019-11) & EN 61000-3-2: 2014

3.4.3 Test Results

N/A

Please refer to Appendix A.4 for Emission and Immunity test results.





3.5. Voltage Fluctuation and Flicker

3.5.1 Test Configuration

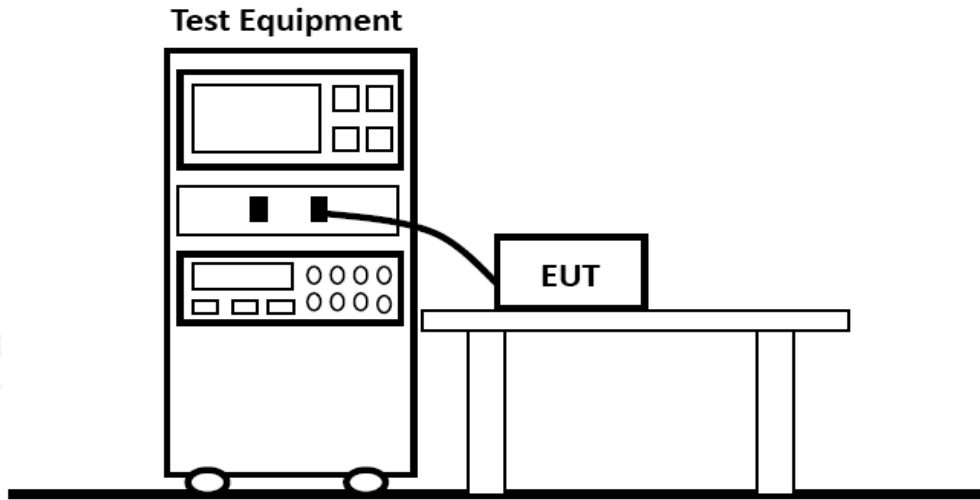

3.5.2 Test Standard

According to ETSI EN 301 489-1 V2.2.3 (2019-11) & EN 61000-3-3: 2013

3.5.3 Test Results

PASS

Please refer to Appendix A.5 for Emission and Immunity test results.



3.6. RF Electromagnetic Field (80 MHz - 6000 MHz)

3.6.1 Test Configuration

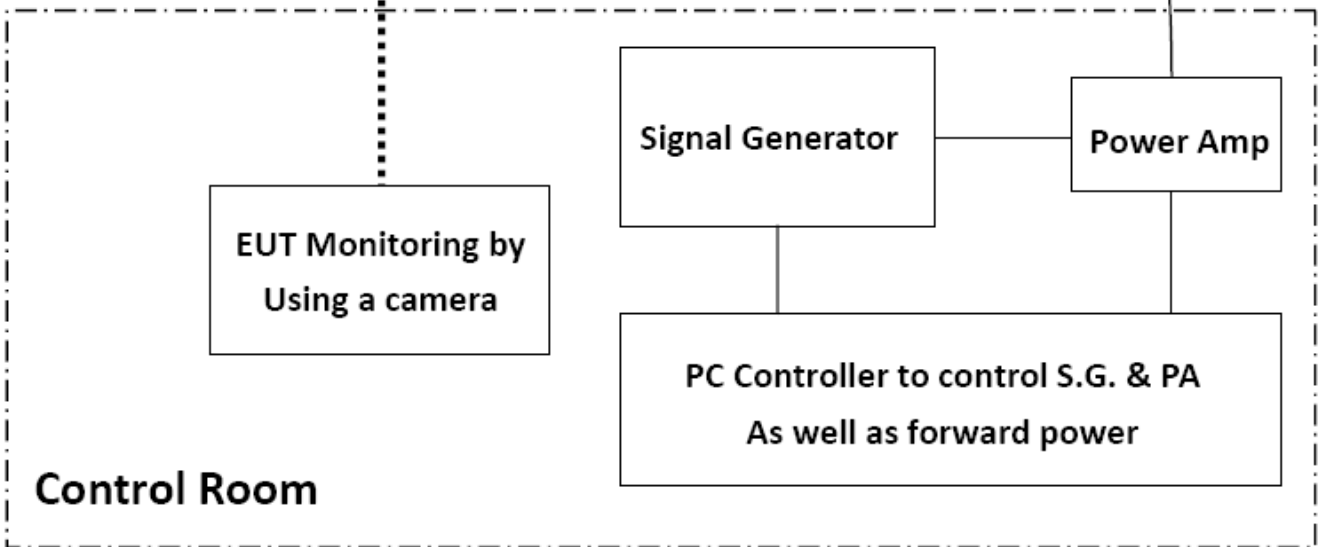
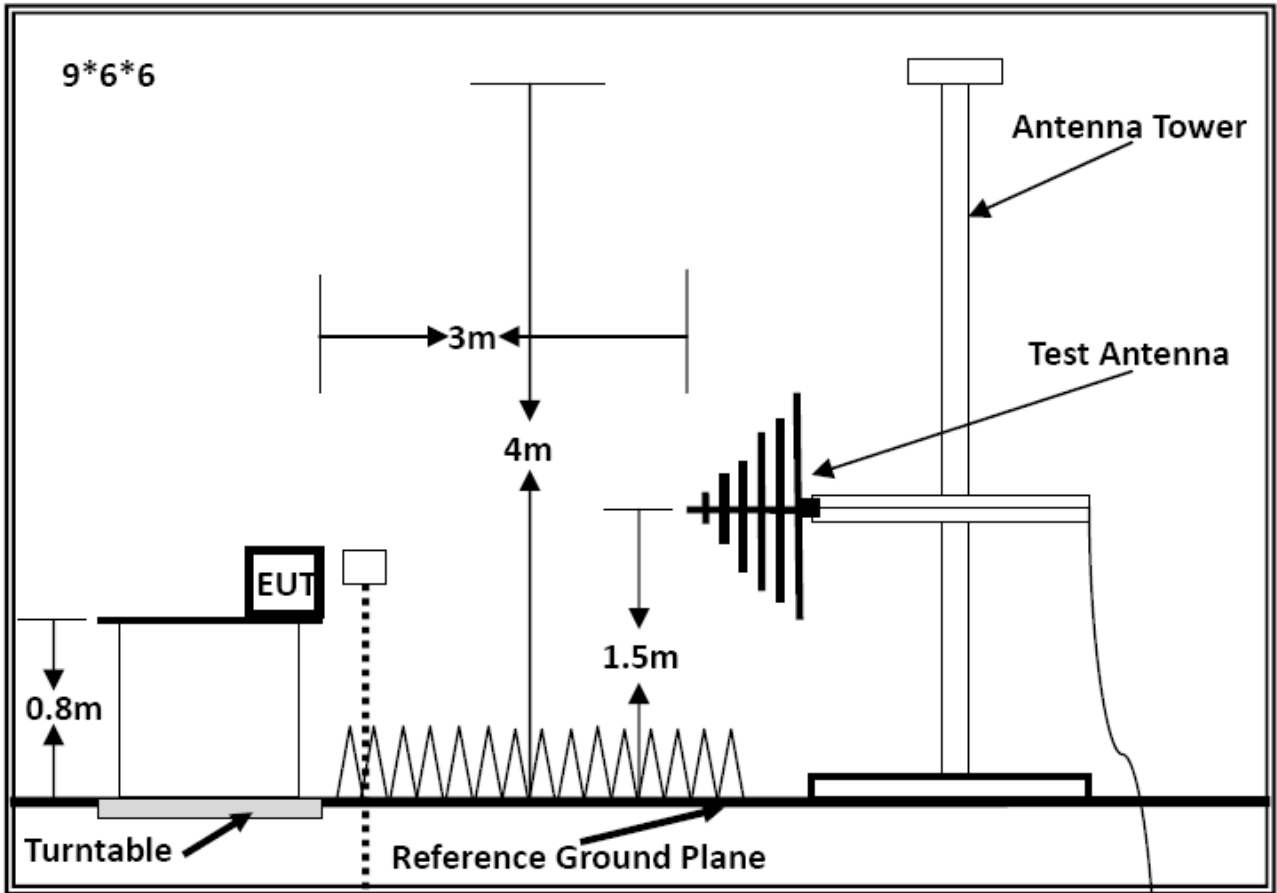



3.6.2 Test Standard

ETSI EN 301 489-1, ETSI EN 301 489-3(EN 61000-4-3: 2006+A2: 2010)

Test level 2 at 3V/m.

3.6.3 Severity Level

Level	Field Strength (V/m)
1	1
2	3
3	10
X	Special
Performance Criterion: A	

3.6.4 Test Procedure

The EUT and its simulators are placed on a turn table which is 0.8 meter above ground. EUT is set 3 meter away from the transmitting antenna which is mounted on an antenna tower. Both horizontal and vertical polarization of the antenna are set on test. Each of the four sides of EUT must be faced this transmitting antenna and measured individually. In order to judge the EUT performance, a CCD camera is used to monitor EUT screen. All the scanning conditions are as follows:

Condition of Test	Remark
Fielded Strength	3 V/m (Severity Level 2)
Radiated Signal	Unmodulated
Scanning Frequency	80-6000MHz
Dwell time of radiated	0.0015 decade/s
Waiting Time	3 Sec.



3.6.5 Test Results

PASS

Please refer to Appendix A.6 for Emission and Immunity test results.



3.7. Electrostatic Discharge

3.7.1 Test Configuration

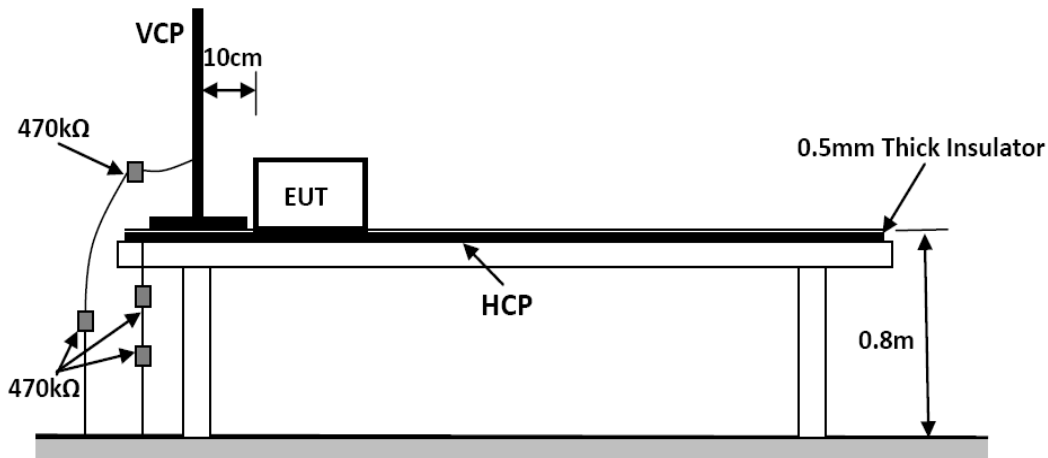

EN 61000-4-2 specifies that a tabletop EUT shall be placed on a non-conducting table which is 80 centimeters above a ground reference plane and that floor mounted equipment shall be placed on a insulating support approximately 10 centimeters above a ground plane. During the tests, the EUT is positioned over a ground reference plane in conformance with this requirement.

For tabletop equipment, a 1.5 by 1.0-meter metal sheet (HCP) is placed on the table and connected to the ground plane via a metal strap with two 470 k Ohms resistors in series. The EUT and attached cables are isolated from this metal sheet by 0.5-millimeter thick insulating material. A Vertical Coupling Plane (VCP) grounded on the ground plane through the same configuration as in the HCP is used.

3.7.2 Test Procedure

ETSI EN 301 489-1 V2.2.3 (2019-11) / EN 61000-4-2: 2009

Test level 3 for Air Discharge at ± 8 kV

Test level 2 for Contact Discharge at ± 4 kV

3.7.2.1 Air Discharge

This test is done on a non-conductive surface. The round discharge tip of the discharge electrode shall be approached as fast as possible to touch the EUT. After each discharge, the discharge electrode shall be removed from the EUT. The generator is then re-triggered for a new single discharge and repeated 10 times for each pre-selected test point. This procedure shall be repeated until all the air discharge completed.

3.7.2.2 Contact Discharge

All the procedure shall be same as Section 3.7.2.1. except that the tip of the discharge electrode shall touch the EUT before the discharge switch is operated.

3.7.2.3 Indirect Discharge For Horizontal Coupling Plane

At least 10 single discharges (in the most sensitive polarity) shall be applied at the front edge of each HCP opposite the center point of each unit (if applicable) of the EUT and 0.1m from the front of the EUT. The long axis of the discharge electrode shall be in the plane of the HCP and perpendicular to its front edge during the discharge.





3.7.2.4 Indirect Discharge For Vertical Coupling Plane

At least 10 single discharges (in the most sensitive polarity) shall be applied to the center of one vertical edge of the coupling plane. The coupling plane, of dimensions 0.5m X 0.5m, is placed parallel to, and positioned at a distance of 0.1m from the EUT. Discharges shall be applied to the coupling plane, with this plane in sufficient different positions that the four faces of the EUT are completely illuminated.

3.7.3 Test Results

PASS

Please refer to Appendix A.7 for Emission and Immunity test results.



3.8. Electrical Fast Transient Immunity

3.8.1 Test Configuration

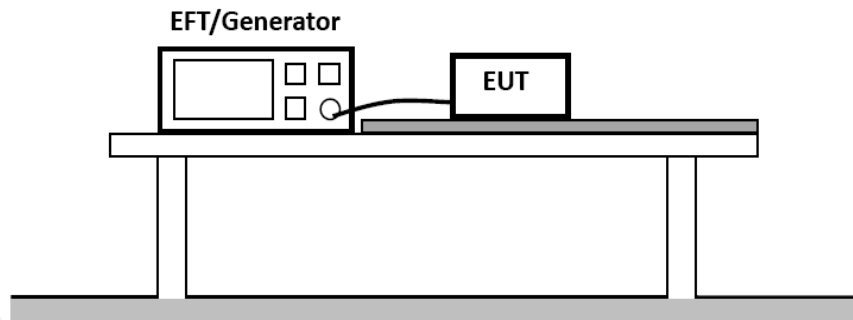

3.8.2 Test Standard

ETSI EN 301 489-1 V2.2.3 (2019-11)/ EN61000-4-4: 2012
 Test level 2 at 1 kV

Test Level		
Open Circuit Output Test Voltage $\pm 10\%$		
Level	On Power Supply Lines	On I/O (Input/Output) Signal data and control lines
1	0.5 kV	0.25 kV
2	1 kV	0.5 kV
3	2 kV	1 kV
4	4 kV	2 kV
X	Special	Special
Performance Criterion: B		

3.8.3 Test Procedure

The EUT is put on the table, which is 0.8 meter high above the ground. This reference ground plane shall project beyond the EUT by at least 0.1m on all sides and the minimum distance between EUT and all other conductive structure, except the ground plane beneath the EUT, shall be more than 0.5m.

3.8.3.1 For input and output AC power ports:

The EUT is connected to the power mains by using a coupling device, which couples the EFT interference signal to AC power lines. Both polarities of the test voltage should be applied during compliance test and the duration of the test is 2 minutes.

3.8.3.2 For signal lines and control lines ports: No I/O ports. It's unnecessary to test.

3.8.3.3 For DC output line ports: It's unnecessary to test.

3.8.4 Test Results

PASS

Please refer to Appendix A.8 for Emission and Immunity test results.



3.9. RF Common Mode

3.9.1 Test Configuration

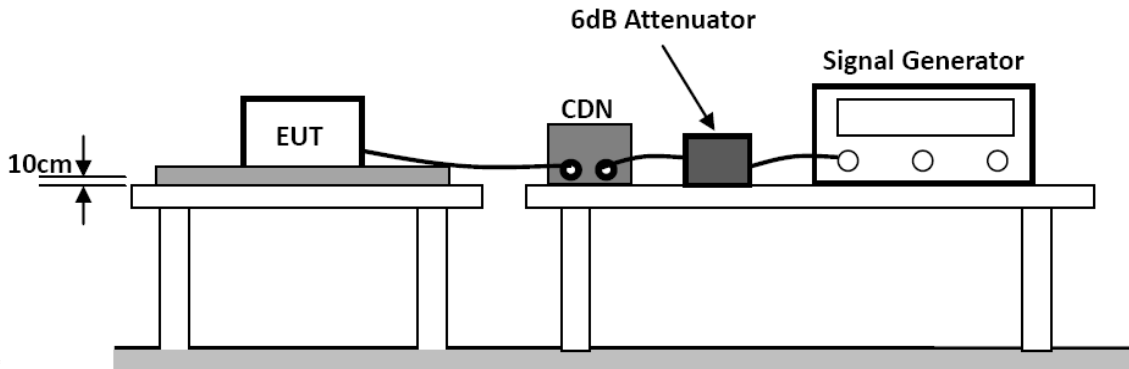

3.9.2 Test Standard

ETSI EN 301 489-1 V2.2.3 (2019-11)/ EN 61000-4-6: 2014

Test level: 3V (r.m.s.) for 0.15MHz ~ 10MHz; 3V (r.m.s.) to 1V (r.m.s.) for 10MHz ~ 30MHz; 1V (r.m.s.) for 30MHz ~ 80MHz

Modulation type: AM

Modulation depth: 80%

Modulation signal: 1 kHz

Test Level	
Level	Voltage Level (r.m.s.) (V)
1	1
2	3
3	10
X	Special
Performance Criterion: A	





3.9.3 Test Procedure

3.9.3.1 Let the EUT work in test mode and test it.

3.9.3.2 The EUT are placed on an insulating support 0.1m high above a ground reference plane. CDN (coupling and decoupling device) is placed on the ground plane about 0.3m from EUT. Cables between CDN and EUT are as short as possible, and their height above the ground reference plane shall be between 30 and 50mm (where possible).

3.9.3.3 The disturbance signal described below is injected to EUT through CDN.

3.9.3.4 The EUT operates within its operational mode(s) under intended climatic conditions after power on.

3.9.3.5 The frequency range is swept from 150kHz to 10MHz using 3V signal level, 10MHz to 30MHz using 3V to 1V signal level, 30MHz to 80MHz using 1V signal level, and with the disturbance signal 80% amplitude modulated with a 1kHz sine wave.

3.9.3.6 The rate of sweep shall not exceed 1.5×10^{-3} decades/s. Where the frequency is swept incrementally, the step size shall not exceed 1% of the start and thereafter 1% of the preceding frequency value.

3.9.3.7 Recording the EUT operating situation during compliance testing and decide the EUT immunity criterion.

3.9.4 Test Results

PASS

Please refer to Appendix A.9 for Emission and Immunity test results.



3.10. Surges, Line to Line and Line to Ground

3.10.1 Test Configuration

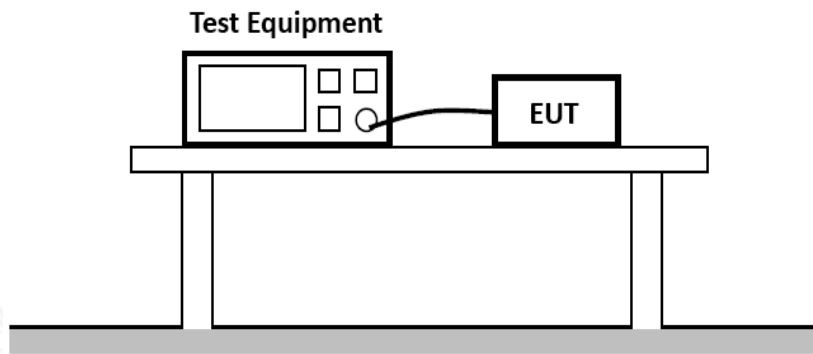

3.10.2 Test Standard

ETSI EN 301 489-1 V2.2.3 (2019-11) / EN 61000-4-5: 2014

L-N: Test level 2 at 1 kV

L-PE, N-PE Test Level 3 at 2kV

Test Level		
Open Circuit Output Test Voltage $\pm 10\%$		
Level	On Power Supply Lines	On I/O (Input/Output) Signal data and control lines
1	0.5 kV	0.25 kV
2	1 kV	0.5 kV
3	2 kV	1 kV
4	4 kV	2 kV
X	Special	Special

Performance Criterion: B



3.10.3 Test Procedure

3.10.3.1 For line to line coupling mode, provide a 0.5 kV 1.2/50us voltage surge (at open-circuit condition).

3.10.3.2 At least 5 positive and 5 negative (polarity) tests with a maximum 1/min repetition rate are conducted during test.

3.10.3.3 Different phase angles are done individually.

3.10.3.4 Record the EUT operating situation during compliance test and decide the EUT immunity criterion for above each test.

3.10.4 Test Results

PASS

Please refer to Appendix A.10 for Emission and Immunity test results.



3.11. Voltage Dips/Interruptions Immunity Test

3.11.1 Test Configuration

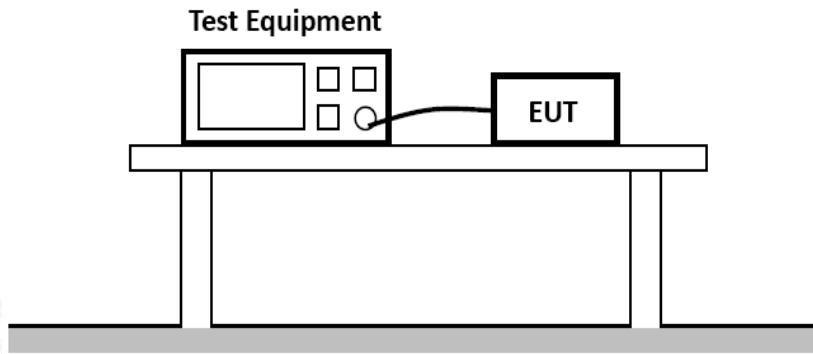

3.11.2 Test Standard

ETSI EN 301 489-1 V2.2.3 (2019-11)/ EN 61000-4-11: 2004+A1:2017
 Test levels and Performance Criterion

Test Level		
Voltage Reduction %U _T	Voltage Dips %U _T	Duration (in Period)
100	0	0.5
100	0	1
30	70	5
Voltage Reduction %U _T	Voltage Dips %U _T	Duration (in Period)
100	0	250
Performance Criterion: B&C		

3.11.3 Test Procedure

3.11.3.1 The interruption is introduced at selected phase angles with specified duration.

3.11.3.2 Record any degradation of performance.

3.11.4 Test Results

PASS

Please refer to Appendix A.11 for Emission and Immunity test results.





4. GENERAL PERFORMANCE CRITERIA FOR IMMUNITY TEST

4.1. Performance criteria for Continuous phenomena applied to Transmitter (CT)

For equipment of type II or type III that requires a communication link that is maintained during the test, it shall be verified by appropriate means supplied by the manufacturer that the communication link is maintained during each individual exposure in the test sequence. Where the EUT is a transmitter, tests shall be repeated with the EUT in standby mode to ensure that any unintentional transmission does not occur.

4.2. Performance criteria for Transient phenomena applied to Transmitter (TT)

For equipment of type II or type III that requires a communication link that is maintained during the test, this shall be verified by appropriate means supplied by the manufacturer during each individual exposure in the test sequence. Where the EUT is a transmitter, tests shall be repeated with the EUT in standby mode to ensure that any unintentional transmission does not occur.

4.3. Performance criteria for Continuous phenomena applied to Receiver (CR)

For equipment of type II or III that requires a communication link that is maintained during the test, it shall be verified by appropriate means supplied by the manufacturer that the communication link is maintained during each individual exposure in the test sequence. Where the EUT is a transceiver, under no circumstances shall the transmitter operate unintentionally during the test.

4.4. Performance criteria for Transient phenomena applied to Receiver (TR)

For equipment of type II or type III that requires a communication link that is maintained during the test, this shall be verified by appropriate means supplied by the manufacturer during each individual exposure in the test sequence. Where the EUT is a transceiver, under no circumstances shall the transmitter operate unintentionally during the test.





Performance criteria for ETSI EN 301 489-3 V2.3.2 (2023-01)

1) Introduction

The performance criteria are used to make an assessment whether a radio equipment passes or fails immunity tests.

Only the performance criteria specified in the present document or in ETSI EN 301 489-1 [1] where referenced shall apply.

The provisions of ETSI EN 301 489-1 [1] clause 6 shall apply, together with clauses 6.2 and 6.3 of the present document.

2) Continuous and non-continuous operation

Latency is the time delay between the initiation and the completion of operation of the EUT. Correct functioning requires completing the relevant operation within the maximum latency time.

Where the maximum latency is specified in the applicable harmonised radio standard (in the wanted performance criterion, or an acknowledge requirement), that value shall be used.

Where this is not the case, then the maximum latency is that required by the intended use of the EUT.

3) Operating modes

Where the EUT has more than one mode of operation (see clause 4.4.1), an unplanned transition from one mode to another is considered as an unintentional response. The EUT shall be tested in all modes to confirm there are no such unintentional responses.





5. LIST OF MEASURING EQUIPMENT

LINE CONDUCTED EMISSION

Item	Equipment	Manufacturer	Model No.	Serial No.	Cal Date	Due Date
1	EMI Test Software	Farad	EZ	/	N/A	N/A
2	EMI Test Receiver	R&S	ESR3	102312	2023-02-25 2024-02-24	2024-02-24 2025-02-23
3	Artificial Mains	R&S	ENV216	101288	2023-06-09	2024-06-08
4	Pulse Limiter	R&S	ESH3-Z2	102750-NB	2023-08-15	2024-08-14
5	Impedance Stabilization Network	TESEQ	ISN T800	45130	2023-10-18	2024-10-17
6	WIDEBAND RADIO COMMUNICATION TESTER	R&S	CMW 500	103818	2023-06-09	2024-06-08

RADIATED DISTURBANCE

Item	Equipment	Manufacturer	Model No.	Serial No.	Cal Date	Due Date
1	EMI Test Software	Farad	EZ	/	N/A	N/A
2	3m Full Anechoic Chamber	MRDIANZI	FAC-3M	MR009	2022-08-17	2025-08-16
3	Positioning Controller	Max-Full	MF7802BS	MF780208586	N/A	N/A
4	By-log Antenna	SCHWARZBECK	VULB9163	9163-470	2021-09-12	2024-09-11
5	Horn Antenna	SCHWARZBECK	BBHA 9120D	9120D-1925	2021-09-05	2024-09-04
6	EMI Test Receiver	R&S	ESPI	101940	2023-08-15	2024-08-14
7	Low-frequency amplifier	SchwarzZBECK	BBV9745	00253	2023-10-18	2024-10-17
8	High-frequency amplifier	JS Denki Pte	PA0118-43	JSPA21009	2023-10-18	2024-10-17
9	MXA Signal Analyzer	Agilent	N9020A	MY50510140	2023-10-18	2024-10-17
10	RS SPECTRUM ANALYZER	R&S	FSP40	100503	2023-07-17	2024-07-16
11	WIDEBAND RADIO COMMUNICATION TESTER	R&S	CMW 500	103818	2023-06-09	2024-06-08

VOLTAGE FLUCTUATION AND FLICKER/HARMONIC CURRENT EMISSIONS

Item	Equipment	Manufacturer	Model No.	Serial No.	Cal Date	Due Date
1	HARMONICS&FLICKER MEASUREMENT SYSTEM	EVERFINE	HFM-3000	P630850CD1411116	2023-02-25 2024-02-24	2024-02-24 2025-02-23
2	HARMONICS&FLICKER TESTING POWER SOURCE	EVERFINE	HFS-4000	P624486CD1411124	2023-02-25 2024-02-24	2024-02-24 2025-02-23
3	WIDEBAND RADIO COMMUNICATION TESTER	R&S	CMW 500	103818	2023-06-09	2024-06-08

RF ELECTROMAGNETIC FIELD

Item	Equipment	Manufacturer	Model No.	Serial No.	Cal Date	Due Date
1	RS Test Software	Tonscend	/	/	N/A	N/A
2	MXG Vector Signal Generator	Agilent	E4438C	MY42081396(6G)	2023-10-18	2024-10-17
3	3m Full Anechoic Chamber	MRDIANZI	FAC-3M	MR009	2022-08-17	2025-08-16
4	RF POWER AMPLIFIER	OPHIR	5225R	1052	2023-06-09	2024-06-08
5	RF POWER AMPLIFIER	OPHIR	5273F	1019	2023-06-09	2024-06-08
6	RF POWER AMPLIFIER	SKET	HAP_0306G -50W	/	2023-06-09	2024-06-08
7	Stacked Broadband Log Periodic Antenna	SCHWARZBECK	STLP 9128	9128ES-145	2023-07-14	2024-07-13
8	Stacked Mikrowellen Log.-Per Antenna	SCHWARZBECK	STLP 9149	9149-482	2023-07-14	2024-07-13
9	RS Electric field probe	narda	EP 601	611WX80208	2023-06-13	2024-06-12
10	Sound Level meter	BK Precision	735	73500873100100 20	2023-06-09	2024-06-08



Shenzhen LCS Compliance Testing Laboratory Ltd.

Add: Room 101, 201, Building A and Room 301, Building C, Juji Industrial Park, Yabianxueziwei, Shajing Street, Bao'an District, Shenzhen, Guangdong, China

Tel: +(86) 0755-82591330 | E-mail: webmaster@lcs-cert.com | Web: www.lcs-cert.com

Scan code to check authenticity



Item	Equipment	Manufacturer	Model No.	Serial No.	Cal Date	Due Date
11	Audio Analyzer	R&S	UPV	1146.2003K02-10 1721-UW	2023-10-18	2024-10-17
12	Mouse Simulation	Bruel & Kjaer	4227	A0304216	2023-06-09	2024-06-08
13	Ear Simulation and supply	Bruel & Kjaer	2669.4182.5 935	A0305284	2023-06-09	2024-06-08
14	Acoustical Calibrators	Bruel & Kjaer	4231	A0304215	2023-06-09	2024-06-08
15	WIDEBAND RADIO COMMUNICATION TESTER	R&S	CMW 500	103818	2023-06-09	2024-06-08

Note: N/A means no calibration requirement

ELECTROSTATIC DISCHARGE

Item	Equipment	Manufacturer	Model No.	Serial No.	Cal Date	Due Date
1	ESD Simulator	SCHLODER	SESD 230	604035	2023-07-17	2024-07-16
2	WIDEBAND RADIO COMMUNICATION TESTER	R&S	CMW 500	103818	2023-06-09	2024-06-08

ELECTRICAL FAST TRANSIENT IMMUNITY

Item	Equipment	Manufacturer	Model No.	Serial No.	Cal Date	Due Date
1	Immunity Simulative Generator	EM TEST	UCS500-M4	0101-34	2023-08-15	2024-08-14
2	Electric fast pulse group generator	3ctest	EFT-4001G	EC0461044	2023-10-18	2024-10-17
3	Capacitive coupling clamp	3CTEST	EFTC	EC0441098	2023-06-09	2024-06-08
4	WIDEBAND RADIO COMMUNICATION TESTER	R&S	CMW 500	103818	2023-06-09	2024-06-08

RF COMMON MODE

Item	Equipment	Manufacturer	Model No.	Serial No.	Cal Date	Due Date
1	Simulator	FRANKONIA	CIT-10/75	A126A1195	2023-08-15	2024-08-14
2	CDN	FRANKONIA	CDN-M2+M3	A2210177	2023-06-09	2024-06-08
3	6dB Attenuator	FRANKONIA	DAM25W	1172040	2023-06-09	2024-06-08
4	Electromagnetic coupling injection clamp	ZHINAN	ZN23203	14017	2023-06-09	2024-06-08
5	WIDEBAND RADIO COMMUNICATION TESTER	R&S	CMW 500	103818	2023-06-09	2024-06-08

SURGES, LINE TO LINE AND LINE TO GROUND

Item	Equipment	Manufacturer	Model No.	Serial No.	Cal Date	Due Date
1	Immunity Simulative Generator	EM TEST	UCS500-M4	0101-34	2023-08-15	2024-08-14
2	Communication wave lightning generator	HTEC	HTSG 70	181701	2023-10-18	2024-10-17
3	Symmetrical data line coupling network	HTEC	HCN 8	182701	2023-10-18	2024-10-17
4	Data line decoupling network	HTEC	HDEC 8	182702	2023-10-18	2024-10-17
5	WIDEBAND RADIO COMMUNICATION TESTER	R&S	CMW 500	103818	2023-06-09	2024-06-08

VOLTAGE DIPS/INTERRUPTIONS IMMUNITY TEST

Item	Equipment	Manufacturer	Model No.	Serial No.	Cal Date	Due Date
1	Voltage dips and up generator	3CTEST	VDG-1105G	EC0171014	2023-06-09	2024-06-08
2	WIDEBAND RADIO COMMUNICATION TESTER	R&S	CMW 500	103818	2023-06-09	2024-06-08



Shenzhen LCS Compliance Testing Laboratory Ltd.

Add: Room 101, 201, Building A and Room 301, Building C, Juji Industrial Park, Yabianxueziwei, Shajing Street,
Bao'an District, Shenzhen, Guangdong, China

Tel: +(86) 0755-82591330 | E-mail: webmaster@lcs-cert.com | Web: www.lcs-cert.com

Scan code to check authenticity



6. PHOTOGRAPHS OF TEST SETUP

Please refer to separated files Appendix B for Photographs of Test Setup_EMC

7. PHOTOGRAPHS OF THE EUT

Please refer to separated files Appendix C for Photographs of The EUT.

-----THE END OF REPORT-----

